VACUUM DRAWER

FIRST USE

Get to know your appliance	3
Select a bag or container	5
Load the drawer	6
Use Vacuum sealing	8
Use Sealing only	10
Use Vacuuming only	11
Use External vacuuming	12
Functions	14
Vacuum levels	15
Clean and maintain your appliance	17
PREMIÈRE UTILISATION FR	19
PRIMER USO SP	37

FISHER & PAYKEL

US CA

VACUUM DRAWER

VB30SDEI3, VB30SMG3, VB30SMB3, VB30SCX3, VB30SPEX3



How to get the best results from your vacuum drawer

- Wash hands, surfaces and utensils well before handling food to be packaged.
- Only package food that is fresh and in perfect condition.
- Ensure all food is cool before packaging. Never vacuum seal warm or hot food.
- Avoid mixing raw and cooked food.
- Some vegetables such as brassicas, pulses, stalks and shoots should be blanched before vacuum sealing.
- Store food in the fridge or freezer after packaging.
- Keep the control panel clean and dry and use clean, dry hands to operate the controls.
- Register your product to get streamlined service support.

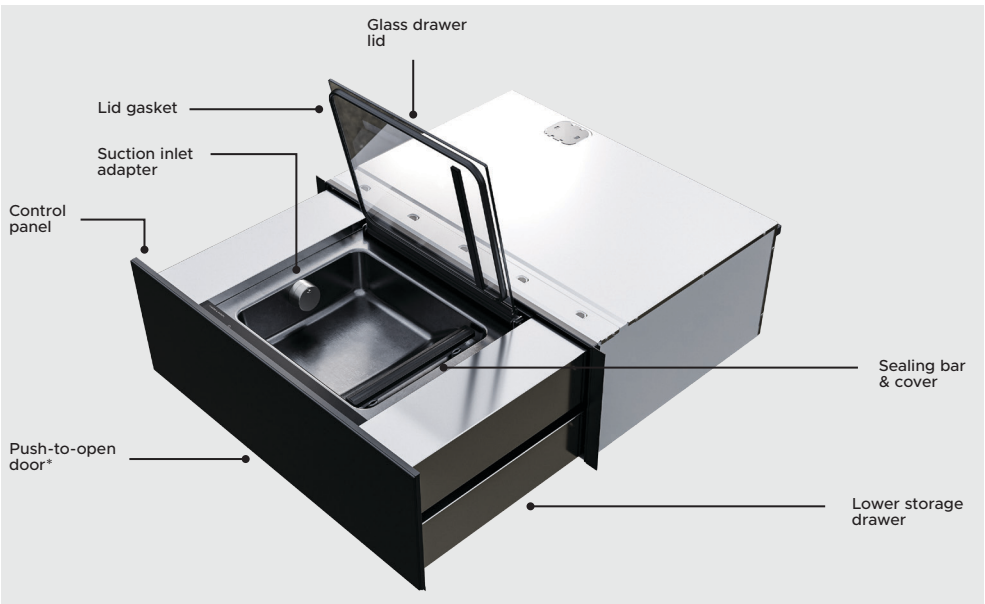

Not shown: vacuum seal bags, external vacuuming kit (adapter, stopper and tube).
Bags and accessories can be stored in the lower storage drawer. To access, close the upper compartment.

*Not available on professional models.

GET TO KNOW YOUR APPLIANCE

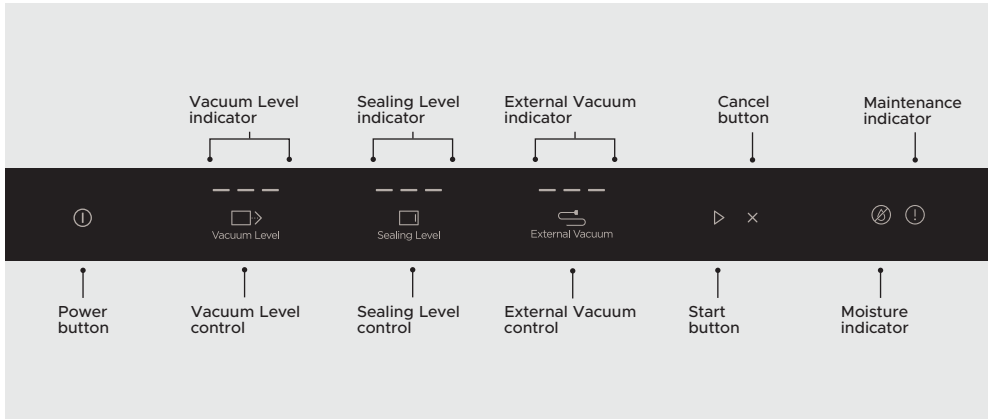

Power button	Press to turn the drawer on or off.
Vacuum Level control	Press to adjust the vacuum pressure level.
Vacuum Level indicator	Indicates what vacuum pressure level is selected.
Sealing Level control	Press to adjust the length of heat sealing.
Sealing Level indicator	Indicates what sealing level is selected.
External Vacuum control	Press to adjust external vacuum pressure level.
External Vacuum indicator	Indicates what external vacuum pressure level is selected.
Start button	Press to start operation.
Cancel button	Press to cancel operation.
Moisture indicator	Indicates when a dry cycle is required to remove moisture from the drawer.
Maintenance indicator	Indicates when the drawer requires maintenance to maintain optimal performance.

SELECT A BAG OR CONTAINER

Your vacuum drawer can be used to seal or vacuum seal food in bags, seal or reseal jars, and to remove air from glass bottles and vacuum containers.

VACUUM BAGS

Selecting a vacuum bag:

- Your drawer is supplied with vacuum bags in two different sizes. These can be used for temperatures between -40°F (-40°C) to 239 °F (115°C).
- We recommend using the supplied vacuum seal bags or commercially available bags suitable for vacuum sealing with a maximum width of 10 1/4" (260mm).
- If using other bags, such as resealable freezer bags, we recommend only using them for vacuum sealing. You may need to adjust the heat sealing time to suit the material of the bags.
- Do not use polycarbonate plastic bags as they can soften and damage the sealing bar.

Filling a vacuum bag:

- Ensure the top edge of the bag where it seals stays clean so that it seals properly.
- Fold the top of the bag out to keep clean while filling.
- Only fill the bag up to two-thirds full.

Always pierce or open vacuum sealed food before placing in a microwave so that the bag does not burst.

Vacuum sealed food can be steamed at a low temperature in a steam cooker or in our Fisher & Paykel Combi-Steam ovens using Sous Vide function. Use only the vacuum bags supplied by Fisher & Paykel for this method.

JARS

You can use the vacuuming only function to reseal jars with screw-top lids. Ensure any jars used are not taller than the maximum height, as this may damage the drawer lid. Do not use damaged or cracked jars as these could implode during vacuuming.

Maximum height: 3 3/8" (80mm)

BOTTLES AND CONTAINERS

You can use the external vacuuming function and kit to remove air from glass bottles or vacuum containers. Ensure bottles and containers are food safe and suitable for vacuuming. We recommend using commercially available vacuum containers. Do not use damaged or cracked bottles or containers as these could implode during vacuuming.

LOAD THE DRAWER

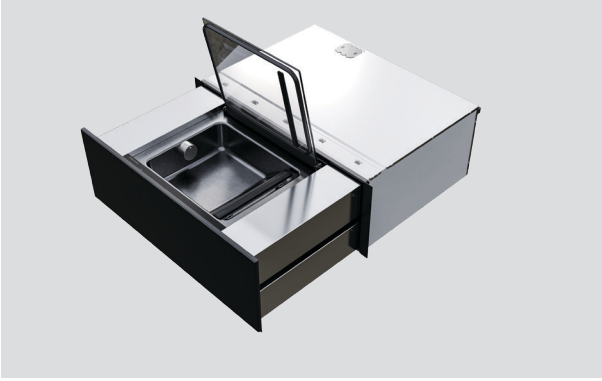

1. Open the drawer and the drawer lid.



2. Place bag or jar in the drawer.



3. Close the lid.

LOAD THE DRAWER

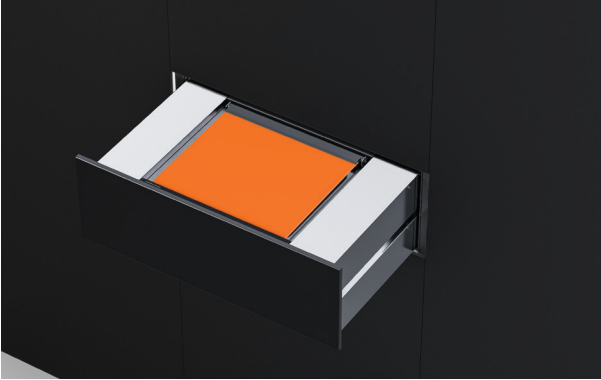

4. Before pressing start, hold down the lid until vacuuming begins (vacuuming and vacuum sealing only).

Bags

Position the opening of the bag across the sealing bar. Ensure it is centred and crease free.

Jars

Loosely screw on lids and place jars inside the drawer. Ensure they are not too tall for the drawer.

Bottles and containers for external vacuuming

Place bottles and containers on a flat and stable surface near the drawer. The drawer lid does not need to be closed for external vacuuming.

USE VACUUM SEALING

Use vacuum sealing to package food in bags for food storage, marinating, portioning or preparing for sous vide cooking. Vacuum sealing uses pressure to remove air from the bag and heat to seal it closed.



Vacuum Level

1. Press the power button to turn on the drawer.



Vacuum Level

2. Adjust the vacuum level as needed to suit the food being packaged.



Vacuum Level



Sealing Level

3. Adjust the sealing level as needed to suit the bag being used.

USE VACUUM SEALING

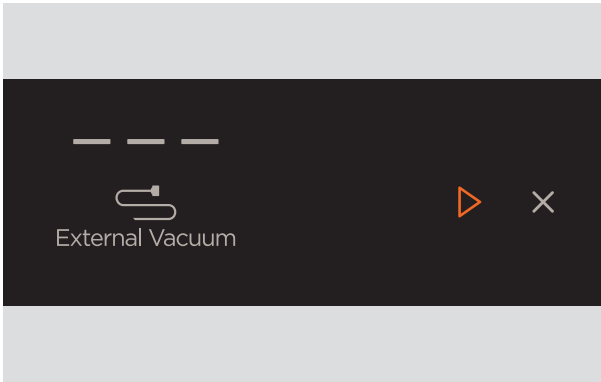

4. Press the start button while holding down the lid. Once vacuum sealing begins the lid will stay closed.

At the end of the cycle

Once the cycle is complete a tone will sound, the drawer will switch off automatically and the lid will be released. Remove items and close the drawer.

Cancelling

Press the cancel button at any point to cancel the cycle. If the bag is not yet sealed then the drawer may continue running until it reaches a point in the cycle when it can stop.

USE SEALING ONLY

Use sealing only to seal or reseal bags without removing air. This is ideal for packaging and storing delicate foods to preserve freshness and extend shelf life.



Before you begin:

Place the bag in the drawer and turn on the drawer.

1. Adjust the vacuum level to off.



2. Adjust the sealing level as needed to suit the bag being used.



3. Close the lid and press the start button.

USE VACUUMING ONLY

Use vacuum only to seal or reseal jars with screw-top lids. This is ideal for storing food or for resealing open jars to preserve freshness and extend shelf life. The maximum height for jars being sealed is 3 3/8" (80mm).



Before you begin:

Place the jars in the drawer and turn on the drawer.

1. Adjust the vacuum level as needed. We recommend using level 1 for sealing jars.

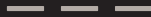
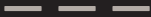

2. Adjust the sealing level to off.



3. Close the lid and press the start button.

USE EXTERNAL VACUUMING

Use external vacuuming to release air from glass bottles or vacuum containers to prevent oxidation. This is ideal for preserving the quality and shelf life of things like oil or wine. You will need the supplied external vacuuming kit for this function.

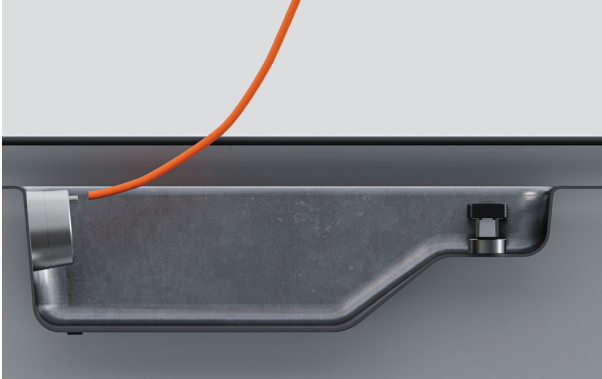

Connect one end of the supplied tube to the suction inlet adapter inside the drawer.

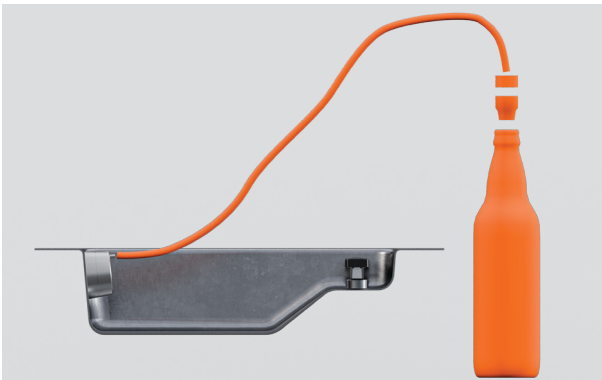

To release air from a bottle:
Connect the stopper adaptor and stopper to the other end of the tube. Place the stopper in the bottle.

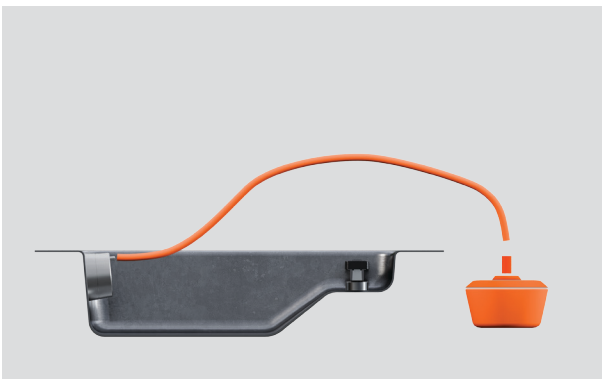

To release air from a vacuum container:
Connect the other end of the tube to the vacuum container, using an adapter if needed.

USE EXTERNAL VACUUMING

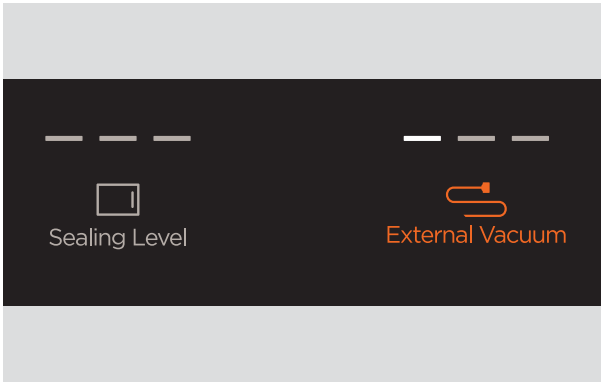

1. Turn the drawer on, then adjust the external vacuum level as needed to suit the food being stored.

We recommend using level 1 for bottles of wine to avoid the gas in the wine being affected.

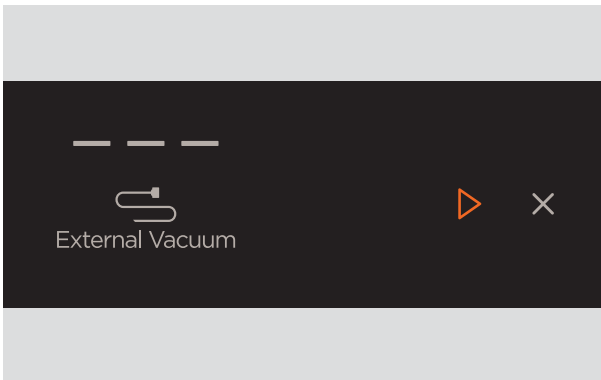

2. Press the start button. You do not need to close the drawer lid.

FUNCTIONS

Your vacuum drawer has a number of functions for food storage, marinating, portioning and preparing food for sous vide cooking.

VACUUM SEALING

For removing air and sealing food in vacuum seal bags. Ideal for marinating or preparing food for sous vide cooking.

VACUUMING ONLY

For vacuum sealing jars with screw-top lids. Ideal for storing food or resealing open jars to preserve freshness and extend shelf life.

SEALING ONLY

For sealing bags shut without removing air to preserve freshness and extend shelf life.

EXTERNAL VACUUMING

For releasing air from glass bottles or vacuum containers to prevent oxidation. Ideal for preserving the quality and shelf life of things like oil or wine.

VACUUM LEVELS

Adjust the vacuum pressure level depending on how delicate items are and how they will be used or stored.

OFF (SEALING ONLY)

For sealing fragile and delicate foods while maintaining shape and consistency.

Ideal for foods that might be crushed if vacuum sealed, such as:

- Crisps
- Salad

LEVEL 1

For packaging softer fruit and foods high in liquid, and for sealing or resealing food in glass jars.

Ideal for foods such as:

- Soft fruit (berries, plums, apricots, bananas)
- Liquids (soups, sauces, stews)
- Meat with a lot of liquid (wine or vinegar marinades, brine)
- Nuts and seeds
- Sealing jars and bottles (dry goods, sauces, pestos)

LEVEL 2

For packaging firmer fruit, softer vegetables, fish, and foods with a small amount of liquid.

Ideal for foods such as:

- Firm fruit (apples, pears)
- Soft vegetables (peppers, tomatoes, zucchini)
- Fish (whole or filleted)
- Meat with some liquid (in sauce or thicker marinades)

LEVEL 3

For packaging firmer vegetables and meat, or preparing food to be frozen.

Ideal for foods such as:

- Meat without liquid (seasoned or unseasoned)
- Root vegetables (carrots, beetroot, sweet potato)
- Hard cheeses
- Food to be frozen

SEALING LEVELS

Adjust the sealing level to suit the material thickness of the vacuum bag being used.

A higher sealing level means a longer sealing time. The thicker the bag the higher sealing level is required.

If sealing multiple bags in a row, the sealing bar will become increasingly hot. We recommend selecting a lower setting or allowing the sealing bar to cool down in between each cycle.

CLEAN AND MAINTAIN YOUR APPLIANCE

Make these steps a regular part of your cleaning routine to get the best results from your appliance.

- Ensure the drawer is turned off and allow to cool before cleaning.
- Clean the drawer after every use.
- Wipe up any spills immediately.
- Do not use steam or high pressure cleaners.

Drawer front

Use a soft, damp cloth and mild detergent and dry immediately with a soft cloth. For stainless steel models, rub in the direction of the polish lines when cleaning the door.

Inside the drawer

Use a soft, damp cloth and mild detergent to clean inside the drawer then dry with a soft cloth. Do not allow spills to sit in the drawer or to spill over the sides. You can remove the sealing bar to make it easier to clean inside the drawer.

Glass drawer lid

Clean the drawer lid and gasket a soft, damp cloth then dry with a soft cloth. Do not use detergent on the gasket.

Sealing bar and cover

Remove the sealing bar and cover to clean. Clean with a soft, damp cloth and mild detergent then dry with a soft cloth.

Ensure the sealing bar and cover are correctly back in place after cleaning, using the two locating pins in the drawer to position.

External vacuuming parts

Clean the external vacuuming parts (adapter, stopper and tube) with hot water and mild detergent then dry with a soft cloth.



Care, maintenance and troubleshooting information

Scan the QR code or visit fisherpaykel.com and search for your model code.

VB30SDEI3, VB30SMG3, VB30SMB3, VB30SCX3, VB30SPEX3

