

**FISHER & PAYKEL**

**HANDLELESS COMBI-STEAM OVEN**



**MINIMAL**

**OS60SMTNG1 & OS60SMTNB1 models**

**USER GUIDE**

**UK IE EU**



## CONTENTS

---

Safety and warnings	4
First use	9
First use (Function based models)	11
First use (Method based models)	14
Menu	17
Wi-Fi connection and remote mode	18
Water hardness	20
Voice control	21
Manual door opening	22
Cooking options	23
Wired temperature sensor	24
Wireless temperature sensor	25
Sabbath mode (some models only)	26
Oven shelves	27
Cleaning	28
Removing the side racks	30
Replacing oven lights	32
Removing the oven door	34
Cleaning the oven door	36
Steam clean	40
Descaling	41
Dry cycle	42
Troubleshooting	43
Fault codes	47
European Directive 2012/19/EU on Waste Electrical and Electronic Equipment (WEEE)	48
Energy guidelines	49
Service and warranty	50
Customer Care	51

---

### Registration

To register your product visit our website: [fisherpaykel.com/register](http://fisherpaykel.com/register)

**⚠ WARNING!**



**Electric Shock Hazard**

**Failure to follow this advice may result in electrical shock or death.**

- Turn the oven off at the wall before replacing the oven lamp.
- Before carrying out any work on the electrical section of the appliance, it must be disconnected from the mains electricity supply.
- Connection to a good earth wiring system is absolutely essential and mandatory.
- Alterations to the domestic wiring system must only be made by a qualified electrician.

**⚠ WARNING!**



**Fire Hazard**

**Failure to follow this advice may result in overheating, burning, and injury.**

- Do not place aluminium foil, dishes, trays, water or ice on the oven floor during cooking, this will irreversibly damage the enamel. Lining the oven with aluminium foil may cause fire.
- Never use your appliance for warming or heating the room. Persons could be burned or injured or a fire could start.
- Flammable materials should not be stored in an oven or near its surface.
- Do not use adapters, reducers, or branching devices to connect this appliance to the mains power supply.

### ⚠ WARNING!



#### **Cut Hazard**

**Failure to use caution could result in injury.**

- Take care: some edges are sharp.

### ⚠ WARNING!



#### **Hot Surface Hazard**

**Failure to follow this advice could result in burns and scalds.**

- To avoid burns and scalds, keep children away from this appliance.
- Surfaces of the appliance may become hot enough to cause burns. Examples include the oven vent, the surface near the oven vent, and the oven door.
- Do not touch heating elements or interior surfaces of the oven. Heating elements may be hot, even when they are dark in colour.
- Use protection when handling hot surfaces, such as oven shelves or dishes, or when using steam functions.
- Be careful when opening the oven door as hot air and steam can be emitted. Allow hot air and steam to dissipate before removing or replacing food.
- During and after use, do not touch or let clothing or other flammable materials contact heating elements or interior surfaces of the oven until they have had sufficient time to cool.

### READ AND SAVE THIS GUIDE

#### **WARNING!**

To reduce the risk of fire, electrical shock, injury to persons or damage when using the oven, follow the important safety instructions listed below. Read all the instructions before installing or using the oven. Use the oven only for its intended purpose as described in these instructions.

#### **Installation**

- Ensure your appliance is properly installed and earthed by a qualified technician.
- Ensure this oven is connected to a circuit which incorporates an isolating switch providing full disconnection from the power supply.
- Do not install or operate the appliance if it is damaged or not working properly. If you receive a damaged product, contact your dealer or installer immediately.
- Please make this information available to the person installing the appliance—doing so could reduce your installation costs.
- This appliance must be installed and connected to the mains power supply only by a suitably qualified person according to these installation instructions and in compliance with any applicable local building and electricity regulations. Failure to install the appliance correctly could invalidate any warranty or liability claims.
- If the power supply cable is damaged, it must be replaced by the manufacturer, its service agent or similarly qualified person in order to avoid a hazard.
- Isolating switch: make sure this oven is connected to a circuit which incorporates an isolating switch providing full disconnection from the power supply in accordance with the wiring rules.
- The oven must be earthed.
- Do not use adaptors, reducers or branching devices to connect the oven to the mains electricity supply, as they can cause overheating and burning.
- The appliance must not be installed behind a decorative door in order to avoid overheating.
- Please take extra care not to damage the lower trim of the oven during installation. The trim is important for correct air circulation and allows the door to open and close without obstruction. The manufacturer does not accept any responsibility for damage resulting from incorrect installation.

#### **Servicing**

- Do not repair or replace any part of the appliance unless specifically recommended in the user guide. All other servicing should be undertaken by a Fisher & Paykel trained and supported service technician or qualified person.

#### **Fire Hazard**

- Do not use water on grease fires. Smother the fire or flame or use a dry chemical or foam type extinguisher.
- Use only dry oven mitts or potholders. Moist or damp potholders on hot surfaces could result in burns from steam. Do not let potholders touch hot areas or heating elements. Do not use a towel or a bulky cloth for a potholder. It could catch fire.
- Do not heat unopened food containers. They can build up pressure that may cause the container to burst and result in injury.

# SAFETY AND WARNINGS

---

## Food Safety

- Leave food in the oven for as short a time as possible before and after cooking. This is to avoid contamination by organisms which may cause food poisoning. Take particular care during warm weather.

## General Use

- This product has been designed for use in a domestic (residential) environment. This product is not designed for any commercial use. Any commercial use by the customer will affect this product's manufacturer's warranty.
- Household appliances are not intended to be played with by children.
- Children should not be left alone or unattended in the area where the appliance is in use. They should never be allowed to sit or stand on any part of the appliance.
- Children of less than 8 years old must be kept away from the appliance unless continuously supervised.
- Cleaning and user maintenance shall not be carried out by children without supervision.
- Do not store things children might want above the oven. Children could be burned or injured while climbing on the oven to retrieve items.
- Do not place heavy objects on the oven door.
- Always keep oven vents unobstructed. Do not wear loose fitting or hanging garments when using the appliance. They could ignite or melt if they touch an element or hot surface and you could be burned.
- Caution: Hot air can blow from the vent at the top of the oven as part of the oven's cooling system.
- Always position shelves in the desired location while the oven is cool (before preheating). If a shelf must be removed while the oven is hot, do not let the oven mitts or potholder contact hot heating elements in the oven or the base of the oven.
- Use only bakeware approved for ovens. Follow the bakeware manufacturer's guidance.
- Always place oven racks in desired location while oven is cool. If rack must be moved while oven is hot, do not let potholder contact hot heating element.
- Do not touch heating elements or interior surfaces of your oven. Heating elements and interior surfaces may be hot even though they are dark in color and could cause burns. The oven door, vent openings and surfaces near these openings may also become hot.
- This appliance is configurable to allow remote operation at any time. Do not store flammable materials or temperature sensitive items inside, on top or near the appliance.
- Neither the temperature sensor or aluminium foil must come in contact with the oven elements.
- Only use a temperature sensor recommended for this oven.
- **WARNING:** Accessible parts may become hot during use. Young children should be kept away.

## Cleaning

- Do not clean the oven seal or use any oven-cleaning products on it. It is essential for a good seal, which ensures that the oven operates efficiently. Care should be taken not to rub, damage, move or remove the oven seal.
- Do not use oven cleaners, harsh/abrasive cleaning agents, waxes, or polishes. No commercial oven cleaner, oven liner, or protective coating of any kind should be used in or around any part of the oven.
- Do not use harsh/abrasive cleaners, scourers or sharp metal scrapers to clean the oven door glass since they scratch the surface, which may result in the glass shattering.

## SAFETY AND WARNINGS

---

- Clean only the parts listed in this manual.
- Do not use a steam cleaner to clean any part of the oven.
- The door gasket is essential for a good seal. Care should be taken not to rub, damage or move the gasket.

### **Light source information**

- This product contains a light source of energy efficiency class G. The light source used in this appliance is not suitable for room illumination.

## FIRST USE



### Features and accessories

- |  |                                  |
|--|----------------------------------|
| ① Oven controls                            | ⑦ Temperature sensor             |
| ② Water tank compartment (behind controls) | ⑧ Grill rack                     |
| ③ Oven lights                              | ⑨ Steam dish (large)*            |
| ④ Shelves                                  | ⑩ Perforated steam dish (small)* |
| ⑤ Side racks                               | ⑪ Perforated steam dish (large)* |
| ⑥ Drip tray                                | ⑫ Roasting dish                  |
|  | ⑬ Baking tray                    |

Not shown: door opening tool, descale solution (x2)

Not all accessories are provided with all models. To purchase additional accessories go to [www.fisherpaykel.com](http://www.fisherpaykel.com)

\*Not intended for use over 100°C

## FIRST USE

The screen layout of your oven may be different depending on your model. Select your screen layout below to go to the correct section for your model.

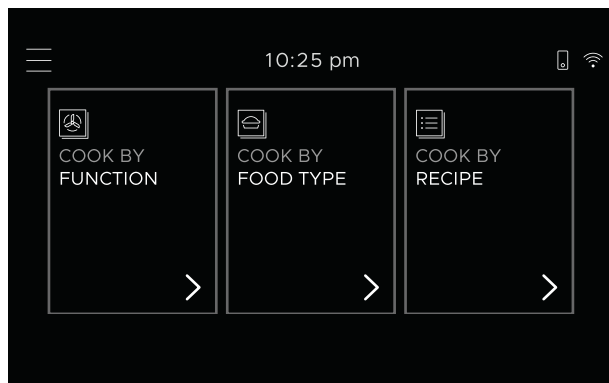

Function based models

Refer to page 11-13 for first use instructions.

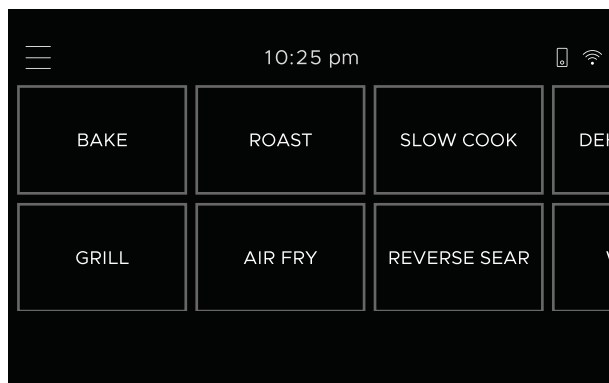

Method based models

Refer to page 14-16 for first use instructions.

### Before you begin

- Ensure all cable ties and packaging have been removed.
- Connect your oven to Wi-Fi to operate remotely using the app. For more information refer to 'Wi-Fi Connection & Remote mode'.
- Set the time. To change the time at any point go to **SETTINGS** and select **CLOCK: SET TIME**
- Set the water hardness according to the instructions under 'Water hardness'.
- Condition your oven using the instructions below.

### Conditioning the oven

We recommend conditioning your oven for 1 hour before you first use it for cooking. A small amount of smoke may be produced, so ensure the kitchen is well ventilated. For method based models, go to **TRADITIONAL FUNCTIONS** to set these functions.

1. Set the oven to **BAKE** at 200°C for 30 minutes.
2. Change the function to **FAN GRILL** and heat for 5 minutes.
3. Change the function to **FAN FORCED** and heat for 20 minutes.
4. Wait for the oven to cool completely then wipe with a damp cloth and mild detergent.

## FIRST USE (FUNCTION BASED MODELS)

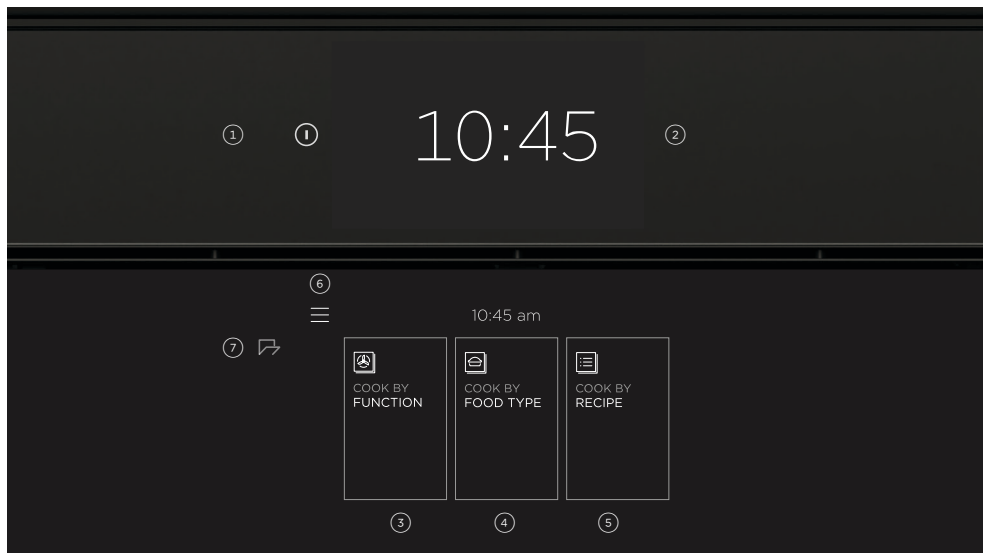

### Control panel

① <b>Power button*</b>	Press and hold to turn the display ON. Press to turn the display OFF, or to cancel cooking.
② <b>Touchscreen display</b>	Use to navigate cooking functions, features and settings.
③ <b>Cook by Function</b>	Choose a function best suited to your cooking requirements.
④ <b>Cook by Food Type</b>	Guided cooking to help you get optimal results.
⑤ <b>Cook by Recipe**</b>	A collection of recipes designed specifically for this style of oven.**
⑥ <b>Menu</b>	Press to access additional features and settings.
⑦ <b>Open door button</b>	Press to open or close the oven door.

\*Low Power mode: If the product is inactive for 20 minutes after use, it will switch to standby mode. To turn low power mode **ON/OFF**, go to **SETTINGS**.

\*\*Recipes available in some languages only.

## FIRST USE (FUNCTION BASED MODELS)



1. Position the shelves at the required height. Ensure shelves are level and correctly positioned with the guard rail at back.

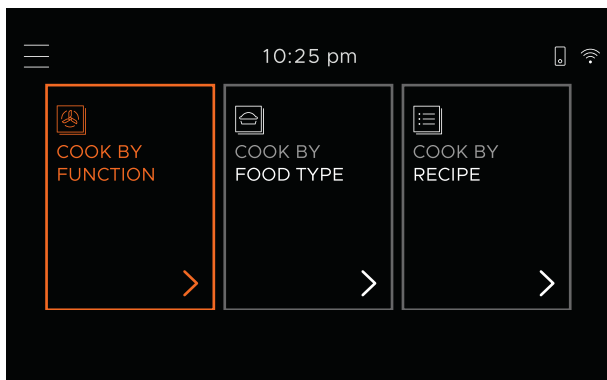

2. Select a cooking mode.

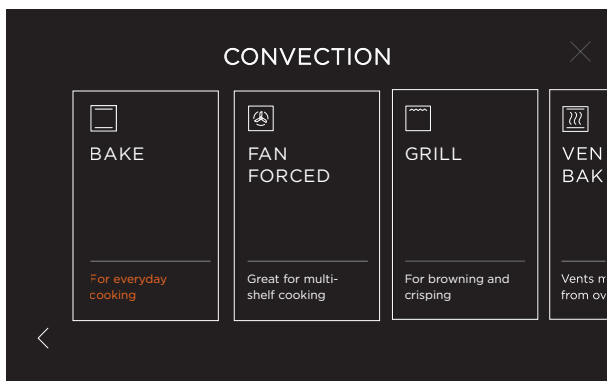

3. Select a function.  
For more information on each function, select the description below the function name.

## FIRST USE (FUNCTION BASED MODELS)

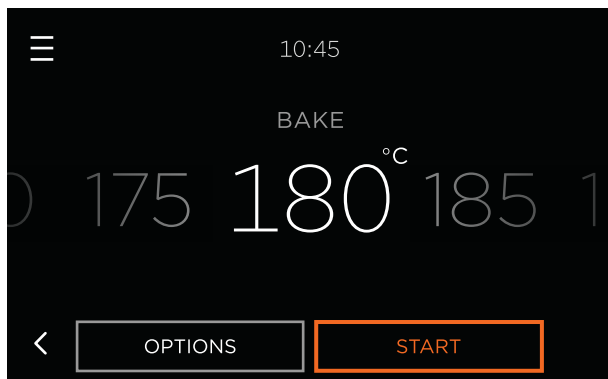

4. Adjust the temperature and add any additional timers or cooking options, then press **START**.

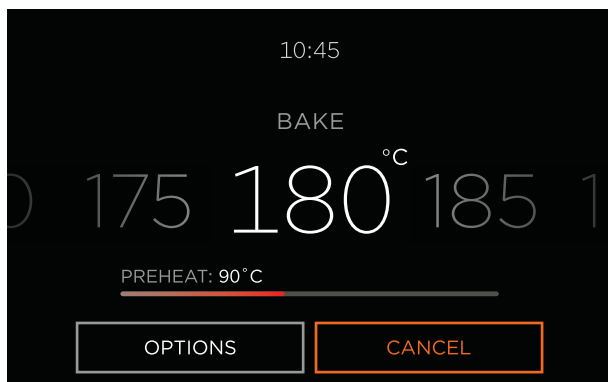

### Preheating

A progress bar will show on the screen while the oven is heating. To prevent burning, wait until the oven has reached temperature before placing food inside.

Some functions do not need to preheat and will not show a progress bar. Place food in the oven when you are ready to start cooking.

Press **CANCEL** at any point to turn the oven off.

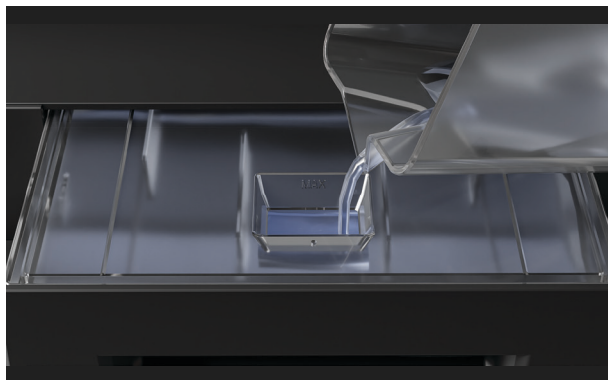

### Cooking with steam

When prompted, open the water tank compartment.

Remove the water tank and fill with fresh water, taking care not to fill past the **MAX FILL** line.

For best results, we recommend filling the tank with fresh water each time you cook.

## FIRST USE (METHOD BASED MODELS)



### Control panel

- |                           |  |
|---------------------------|--|
| ① <b>Power button</b>     | Press and hold to turn the display on.<br>The oven will go into standby after a period of inactivity and the display will turn off, including the clock.<br>If Remote Mode is enabled the power button will pulse to show the oven is connected. |
| ② <b>Cook by Function</b> | Use to navigate cooking methods, functions, features and settings.<br>Touch the screen to wake up the display.   |
| ③ <b>Cooking methods</b>  | Choose from a range of optimised cooking methods or traditional functions.   |
| ④ <b>Menu</b>             | Press to access additional features and settings.  |
| ⑤ <b>Open door button</b> | Press to open or close the oven door   |

## FIRST USE (METHOD BASED MODELS)



1. Position the shelves at the required height. Ensure shelves are level and correctly positioned with the guard rail at back.

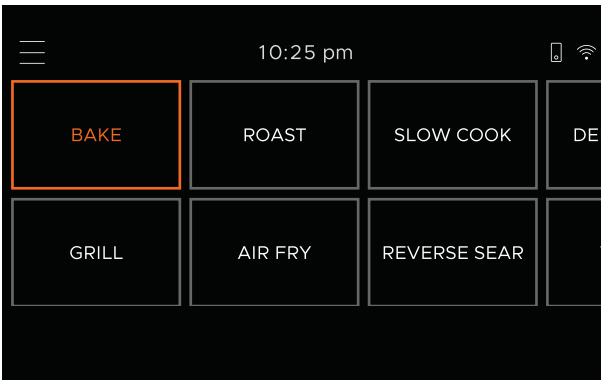

2. Select a cooking method, or scroll to select Traditional Functions or Recipes.

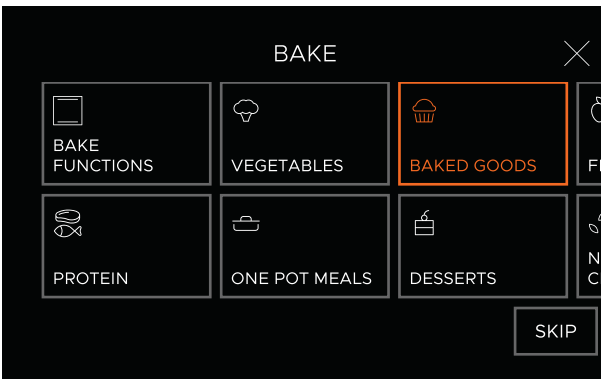

3. Select a food type or an oven function as required.

## FIRST USE (METHOD BASED MODELS)

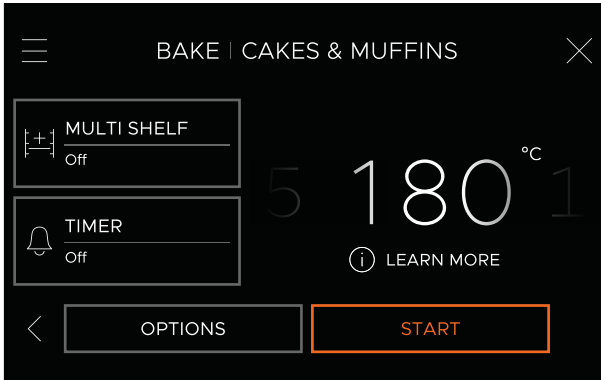

4. Adjust the temperature if needed and add any additional timers or cooking options, then press **START**.

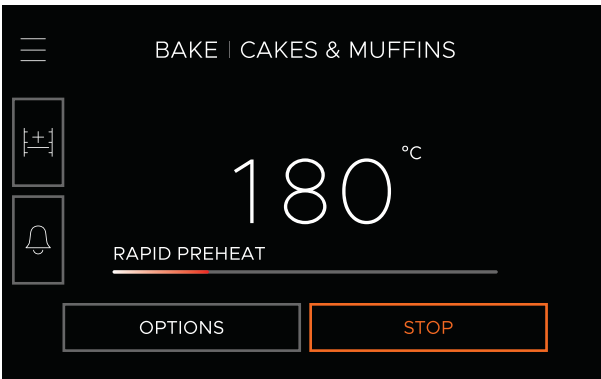

### Preheating

A progress bar will show on the screen while the oven is heating. To prevent burning, wait until the oven has reached temperature before placing food inside.

Some functions and methods do not need to preheat and will not show a progress bar. Place food in the oven when you are ready to start cooking. Press **STOP** at any point to turn the oven off.

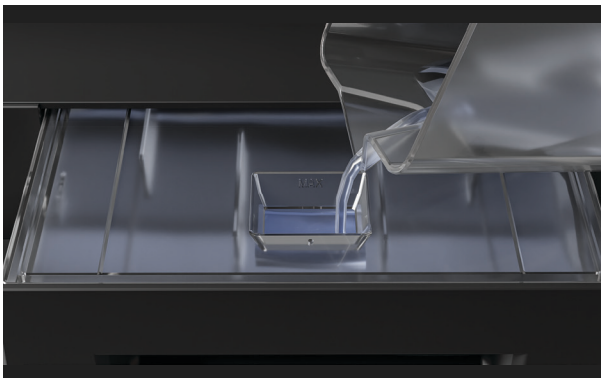

### Cooking with steam

When prompted, open the water tank compartment.

Remove the water tank and fill with fresh water, taking care not to fill past the MAX FILL line.

For best results, we recommend filling the tank with fresh water each time you cook.

## MENU

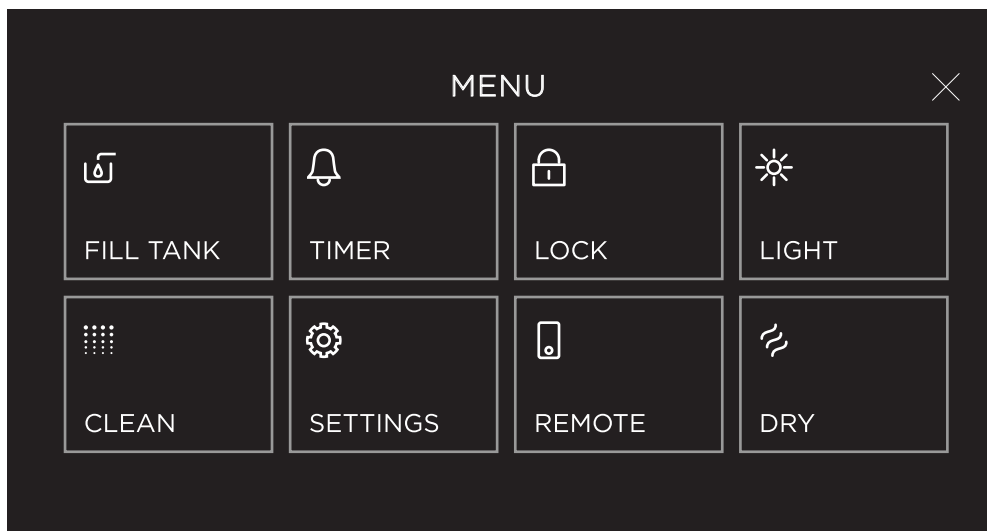

### Menu

#### FILL TANK



Press to open the water tank compartment.

#### TIMER



Use the timer to keep track of cooking times. You can use it at any time, even if you are not using the oven.  
The timer does not turn the oven off. Refer to 'Cooking options' for the automatic cooking options.

#### LOCK



Lock the controls to prevent accidental use. When locked, the controls will be unresponsive and the appliance will not turn on. Press and hold the screen anywhere to unlock.

#### LIGHT



Turn the oven lights **ON/OFF**.

#### DRY



Run a dry cycle to help remove any moisture from your oven.

#### CLEAN



Set a steam clean cycle to clean the inside of the oven. Refer to 'Descaling' or 'Steam clean' for full instructions.

#### SETTINGS



Adjust the settings to suit your preferences or set up a Wi-Fi connection.

#### REMOTE



Connect appliance to your mobile device to operate it remotely via the app.

## WI-FI CONNECTION AND REMOTE MODE

Your appliance may be connected to your home wireless network and operated remotely using the app. Connect your appliance to ensure it stays up to date with the latest software and features.

### Getting started

- Ensure your home Wi-Fi network and Bluetooth on your mobile device are turned on.
- You will be given step-by-step guidance on both your appliance and mobile device.
- It may take up to 10 minutes to connect your appliance.



### On your mobile device

- ① Scan the QR code or go to [www.fisherpaykel.com/connect](http://www.fisherpaykel.com/connect) to download the app on your mobile device
- ② Register and create an account.
- ③ Add your appliance and set up the Wi-Fi connection.

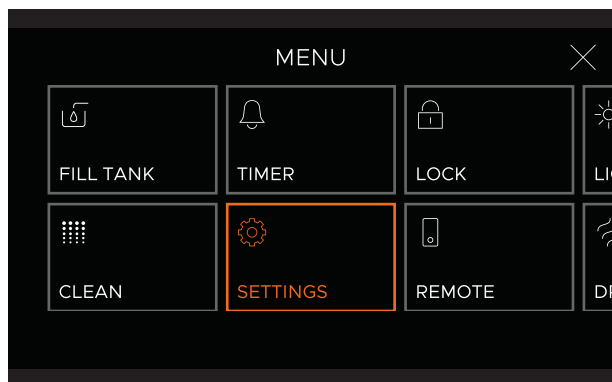

### Connecting to Wi-Fi

1. Go to the menu and select **SETTINGS**.

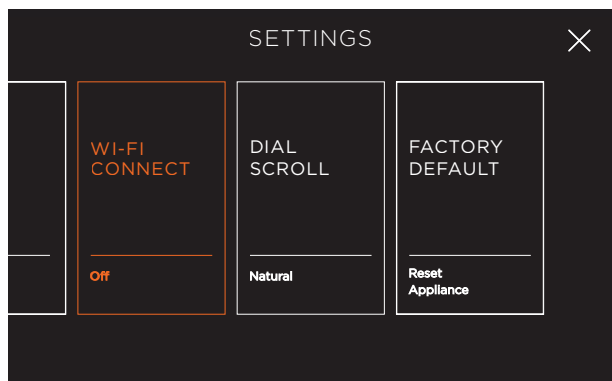

2. Select **WI-FI CONNECT** and follow the instructions onscreen.

## WI-FI CONNECTION AND REMOTE MODE

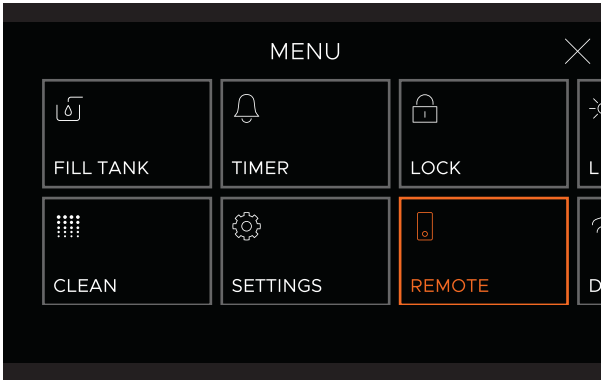

### Enabling Remote Mode

1. Go to the menu and select **REMOTE**.

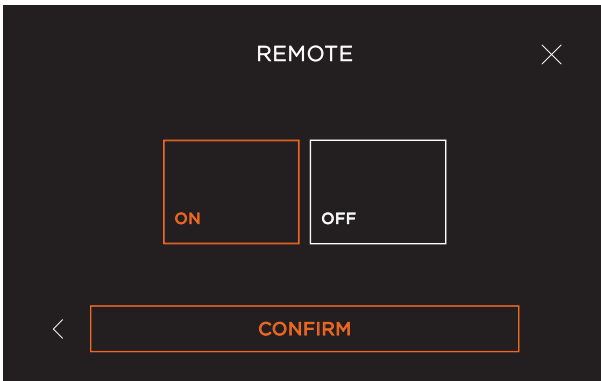

2. Select **ON**, then press **CONFIRM**.

Remote mode is now enabled.

# WATER HARDNESS

Set the water hardness level before using steam functions for the first time. Contact your local water supplier if you are unsure of your water hardness level.

We do not recommend using this product with water hardness above 450ppm.

WATER HARDNESS (PPM)	LEVEL
0 - 100	ZERO
100 - 250	ONE
250 - 350	TWO
350 - 450	THREE

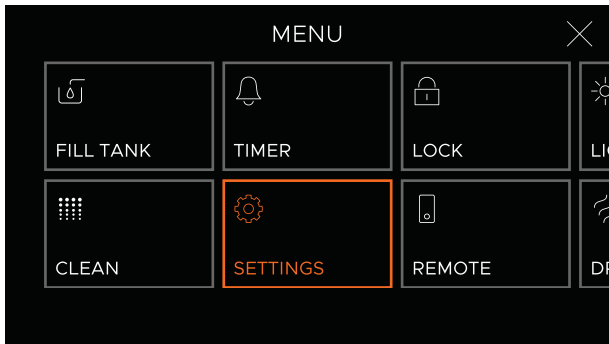

## Setting water hardness level

1. Go to the menu and select **SETTINGS**.

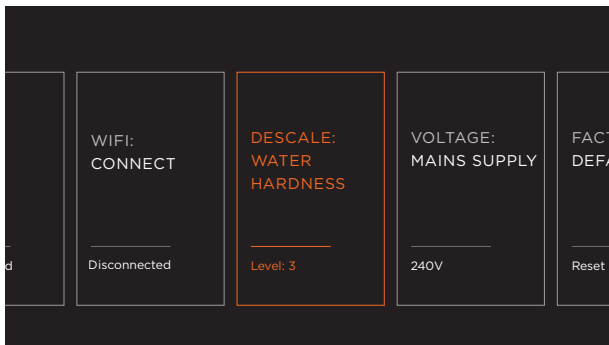

2. Select **DESCALE: WATER HARDNESS**.

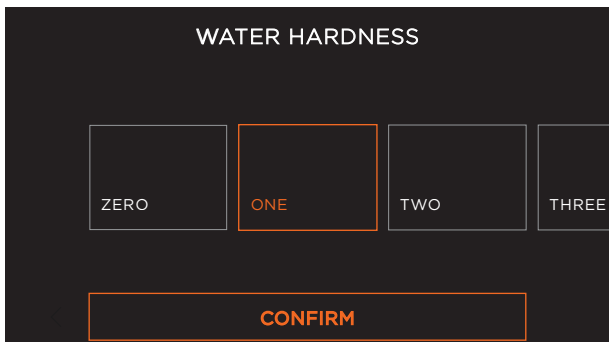

3. Select relevant water hardness level then press **CONFIRM**.

## VOICE CONTROL

Your appliance may be set up to open the oven door using voice control.

Your appliance must be connected to Wi-Fi and have Remote Mode enabled to use voice control. Voice control also requires a smart speaker or your mobile device to control the oven door.

Using voice control to open the oven door should only be done when in view of the appliance, as the oven may be hot. Stand clear when the door is opening.

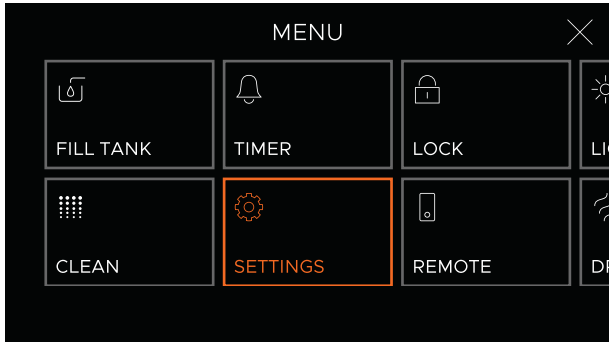

### Enabling voice control

1. Go to the menu and select **SETTINGS**.

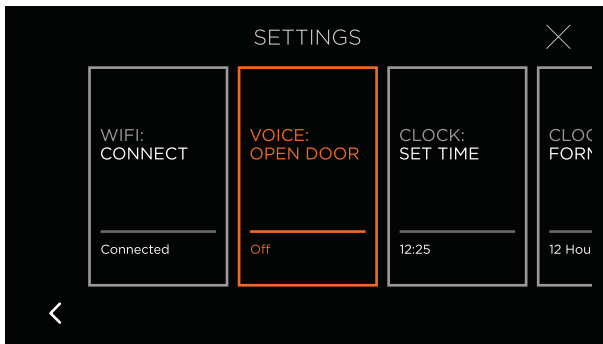

2. Select **VOICE: OPEN DOOR** and follow the instructions onscreen.

## MANUAL DOOR OPENING

---

In the event of a power outage or fault, you may need to open the oven door manually. Your oven comes supplied with a door opening tool for this purpose.



### Opening the door manually

1. Hold the door opener by the loop, with the short end pointing to the right.



2. Carefully insert the door opener at the top right of the oven, between the centre louvre and the top of the door.



3. Rotate the door opener 90 degrees clockwise, then gently pull the door open.

Do not force the door opener if it doesn't turn freely as this could cause damage.

## COOKING OPTIONS

<b>CHANGE FUNCTION</b>	Quickly view and switch functions.
<b>DELAYED COOK</b>	Set the oven to turn on later, cook for a set length of time and turn off automatically.
<b>AUTO OFF</b>	Set the oven to turn off after a set length of time.
<b>TEMPERATURE SENSOR</b>	Use the sensor to monitor cooking and automatically turn the oven off when food is done.

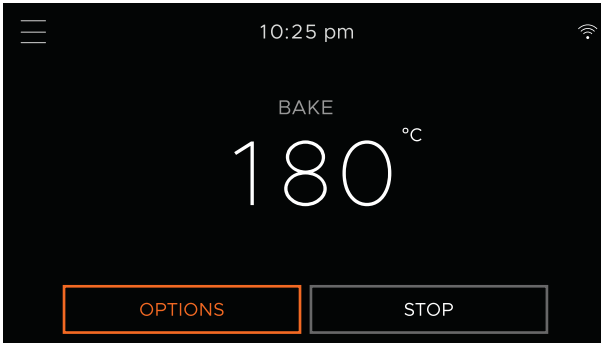

### Accessing options

1. Select a function, then press **OPTIONS**.

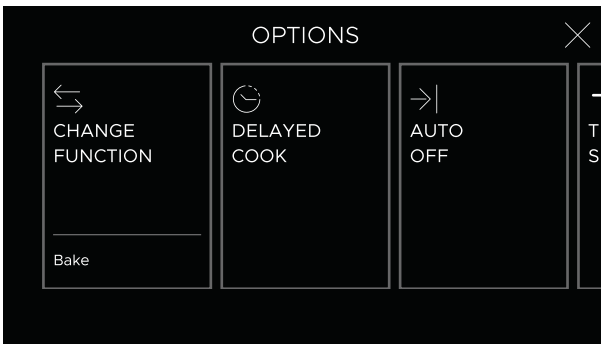

2. Select a cooking option and follow the onscreen instructions.

### Food safety

- Leave food in the oven for as short a time as possible before and after cooking.
- For best results, ensure meat is fully defrosted before cooking. If cooking food from frozen, increase cook time by 50 per cent.
- Rest meat after cooking to allow the internal temperature to continue to rise. High risk foods such as fish should reach a minimum internal temperature of 63-70°C and poultry and minced meat should reach 75-85°C.

### Delayed cook

The grill element may come on while the oven is heating up. Position food on a lower shelf or cover to prevent burning as the oven heats up. When using **DELAYED COOK** we do not recommend using **GRILL**, **FAN GRILL**, **STEAM PROOF**, **STEAM DEFROST** or **AIR FRY**.

## WIRED TEMPERATURE SENSOR

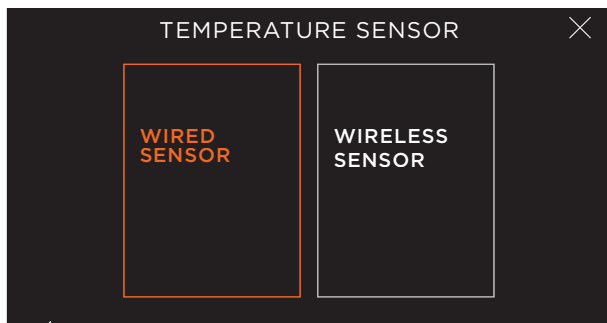

1. Select a cook function  
Go to **OPTIONS** and select **TEMPERATURE SENSOR**, then select **WIRED SENSOR**.

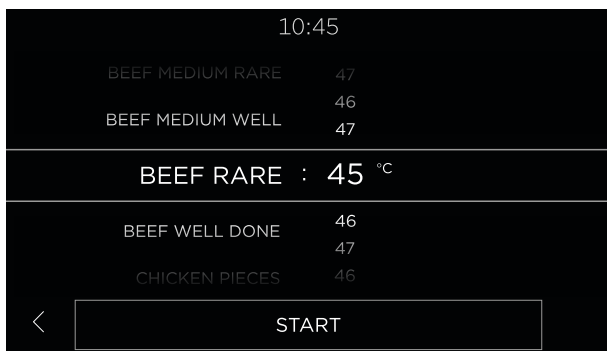

2. Select a food type and removal temperature then press **CONFIRM**.  
Allow your oven time to preheat if necessary.



3. Insert the sensor into your food. Position the sensor in the thickest part of the dish, avoiding fat and bone in meat.  
Ensure the tip of the sensor doesn't protrude out the other side of food or touch cookware.



4. Place food in the oven and plug in the sensor. The sensor will click when it is in place.  
The socket is located inside the oven, on the left hand side.

## WIRELESS TEMPERATURE SENSOR

Your oven may be connected to a compatible wireless temperature sensor. Compatible sensors are available to purchase at [fisherpaykel.com/sensor](http://fisherpaykel.com/sensor).

Ensure your sensor is fully charged before use.

Do not use your wireless sensor to heat food above 100°C or place in an oven above 300°C.

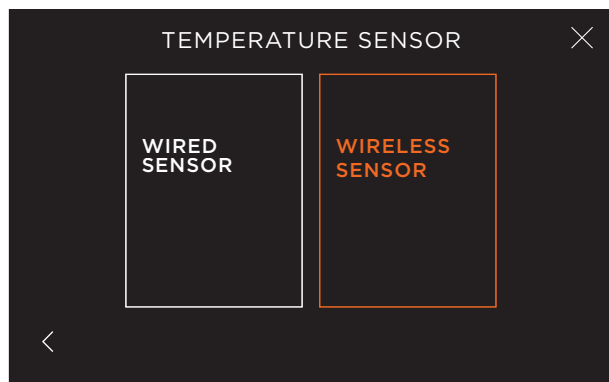

1. Select a cook function  
Go to **OPTIONS** and select **TEMPERATURE SENSOR**, then select **WIRELESS SENSOR**.

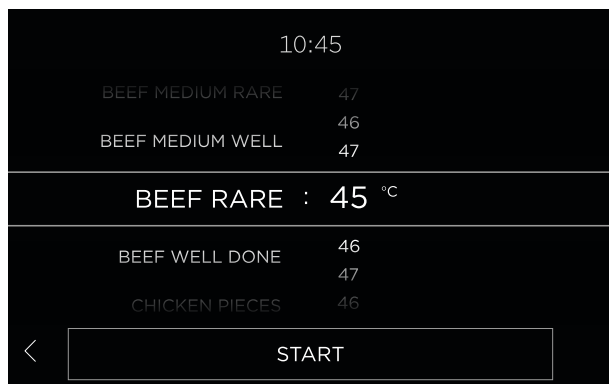

2. Select a food type and removal temperature then press **CONFIRM**.

Allow your oven time to preheat if necessary.

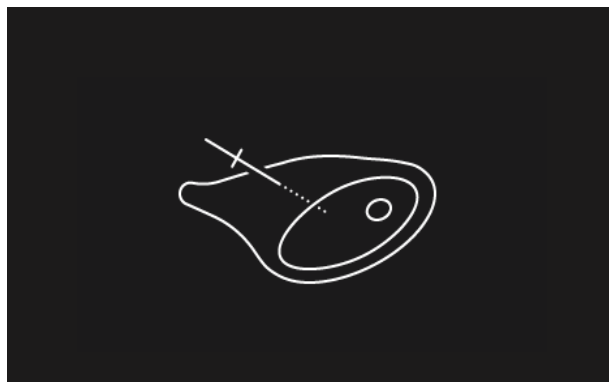

3. Insert the sensor into your food.

Position the sensor in the thickest part of the dish, avoiding fat and bone in meat.

Ensure the tip of the sensor doesn't protrude out the other side of food or touch cookware.

Ensure the sensor is inserted past the minimum line.

Place your food in the oven.

## SABBATH MODE (SOME MODELS ONLY)

For the Sabbath observant. Sabbath Mode sets your oven to heat continuously for as long as required. The display will be unresponsive and no tones or alerts will sound.

While your oven is in Sabbath Mode it can operate at the following temperature levels:

HEAT LEVEL	APPROX TEMP (°C)	APPROX TEMP (°F)	USE
Low	75 - 100	170 - 210	Keep hot food warm
Moderate	155 - 180	310 - 360	Reheat cooked food from cold
High	185 - 210	360 - 410	Cooking raw food

The oven may take some time to get to temperature. If you want to cook immediately after setting Sabbath Mode we recommend preheating the oven before setting. Opening the door frequently or for too long may result in heat loss.

### During Sabbath Mode

- The display will be unresponsive.
- No tones or alerts will sound.
- Wi-Fi will be disconnected.
- The oven light will remain either on or off, depending on your preference.
- Lights, fans and display will not respond to the door opening.
- You will need to use the manual door opening tool to open the door

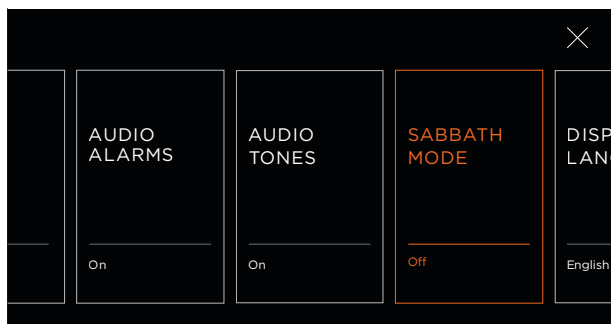

### Setting Sabbath Mode

In the **SETTINGS** menu, select **SABBATH MODE** and follow the instructions onscreen.

The oven will heat for the set length of time and then turn off. At the end of the cook time, the oven will remain in Sabbath Mode until cancelled.

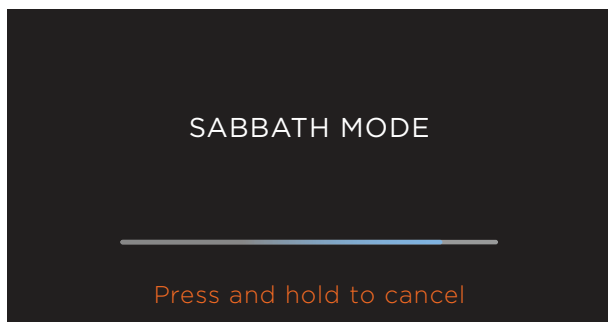

### Cancelling Sabbath Mode

Press and hold anywhere on the screen to cancel.

## OVEN SHELVES

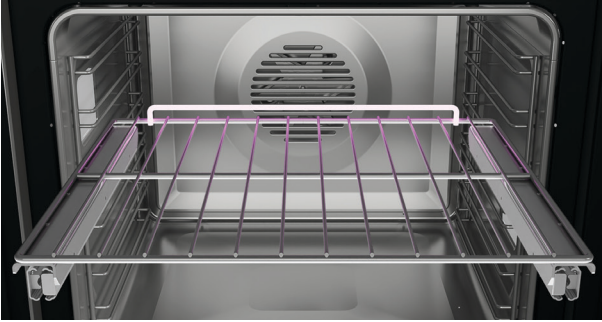

Place shelves in the oven at the required level before heating the oven. Ensure shelves are level and correctly positioned with the guard rail at the back.

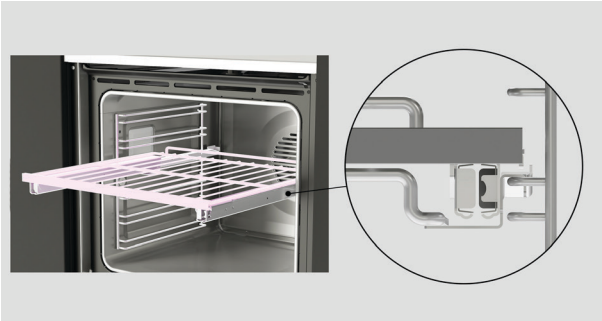

### Sliding shelves

1. Grip shelves at the front, holding the wire shelf and frame together.

Place the shelf on top of the side racks, and push into the oven.

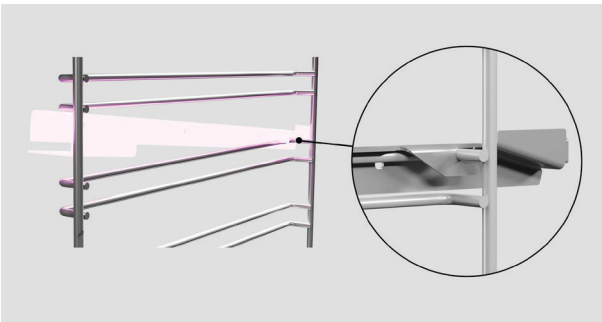

2. Ensure the rear tags are hooked over the side racks on both sides.

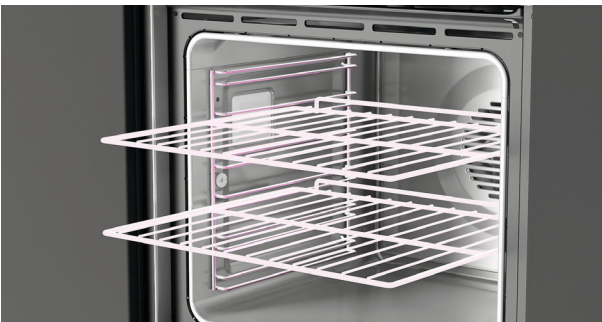

### Wire shelves

Slide shelves into the cavity.

## CLEANING

---

Before cleaning, always allow the oven to cool to a safe temperature. Turn off the power supply before undertaking any manual cleaning or maintenance.

- Never use a steam cleaner.
- Never store flammable substances in the oven.
- Never use abrasive or harsh cleaners, cloths, scouring pads or steel wool. Some nylon scourers may also scratch. Check the label first.
- Never leave alkaline (salty spills) or acidic substances (such as lemon juice or vinegar) on the oven surfaces.
- Never use cleaning products with a chlorine or acidic base.

### Oven door glass

Clean after each use with hot water and mild detergent.

For stubborn stains, try a mixture of baking soda and warm water with a non-abrasive scrubbing pad.

### Do not use the following cleaning products as they may cause damage:

- Plastic or stainless steel scouring pads
- Steel wool
- Metal scrapers
- Abrasive, solvent, oven/household cleaners.

### Inside the oven door

You can take the door apart to clean the glass panes. Refer to 'Cleaning the oven door.'

### Oven door frame and plastic corner clips

Clean with mild detergent and hot water, then wipe dry.

### Oven seal

Do not clean or remove this part. Take care not to rub, damage or move the oven seal.

### Oven cavity

Clean the enamelled surfaces with a damp cloth and a solution of hot water and mild detergent or an ammonia-based cleaner, then wipe dry with a soft cloth.

Clean up any easy-to-reach spills, food or grease stains after each use to prevent them becoming 'baked on'.

You can remove the oven door for greater cleaning access. See 'Removing the oven door'.

### Control Panel

Take particular care when cleaning the control panel glass and screen. Only use a damp cloth with detergent.

Do not use any oven cleaners, harsh or abrasive cleaners, scouring pads, steel wool or sharp metal scrapers on the glass. These may scratch and damage the surface.

## CLEANING

---

### Racks, wire shelves, pans and trays

Clean with a mild detergent and hot water. Do not wash in the dishwasher. Remove the side racks to access the oven lights.

### Sliding shelf

Wipe clean with a damp cloth and mild detergent. Do not wipe off or wash away the white lubricating grease (visible when the shelf is extended).

Do not wash in the dishwasher, immerse in soapy water or use oven cleaner on them. Doing so will prevent the slides from running smoothly.

### Wired temperature sensor

Clean after every use with a mild detergent and hot water, then wipe dry.

Do not wash in the dishwasher, immerse in soapy water or use oven cleaner on it.

### Wireless temperature sensor

Follow the instructions provided with your temperature sensor.

### Drip tray

Empty or wipe out the drip tray regularly to stop it overflowing. The drip tray is at the base of the oven and can be accessed while the oven door is open. Wait for the oven to cool then wipe with a sponge or soft cloth, or lift up to remove and empty.

### Drying the oven

After running a steam function, there may be some moisture left in the oven. Wait for the oven to cool, then wipe out the base of the cavity with a sponge or soft cloth. We recommend running a dry cycle after you have wiped out the base of the cavity to help remove any remaining moisture. Refer to 'Dry cycle' for more information.

### Maximum steam cooking times

The below maximum cooking times apply when using steam functions. We recommend staying within these cooking times to avoid a build-up of condensation inside the oven.

TEMPERATURE (C°)	MAX COOKING TIME (MINS)
100	120
90	120
80	120
70	280
60	320
50	360

## REMOVING THE SIDE RACKS



### Removing the side racks

1. Remove all shelves.



2. Unscrew the nut holding the rack in position. Use a coin to loosen if required.

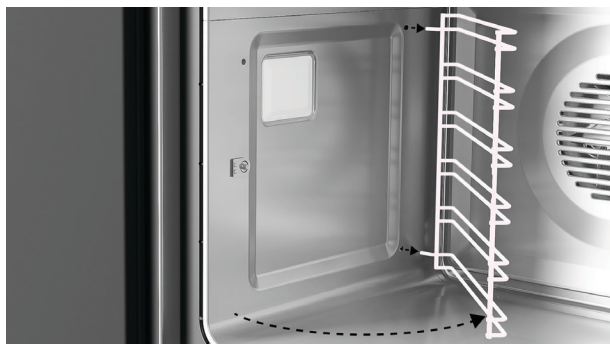

3. Pull the front of the rack clear of the screw and slide forward to remove.

## REMOVING THE SIDE RACKS

---



### Refitting the side racks

1. Slide the prongs into the holes.

Ensure the rack sits flush against the side of the oven.



2. Align the tab with the screw and secure with the nut.

Use a coin to tighten if required.

## REPLACING OVEN LIGHTS

---



### Replacing the oven lights

1. Remove all shelves and side racks.

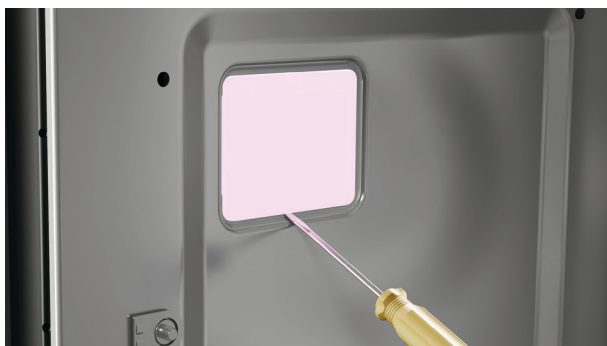

2. Use a flathead screw driver to carefully prise off the glass light bulb cover.

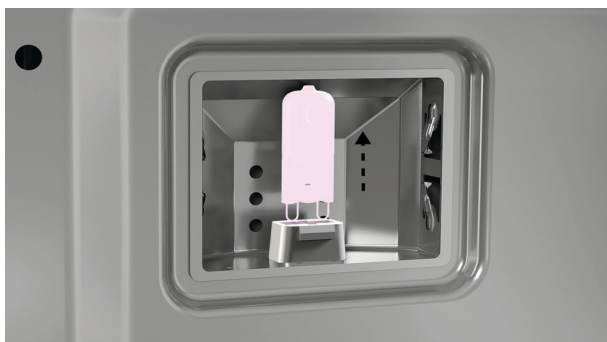

3. Remove the faulty bulb from the socket.

## REPLACING OVEN LIGHTS

---

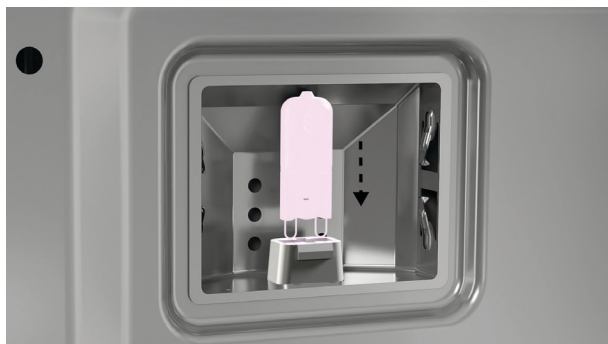

4. Insert the new bulb, using a soft cloth to hold it. Touching the bulb will reduce its lifespan.



5. Replace the cover.



### **Oven light specifications**

G9 220 - 240V/25W  
halogen bulbs.

Replacement bulbs are available via [www.fisherpaykel.com](http://www.fisherpaykel.com). Oven light replacement is not covered by your warranty.

## REMOVING THE OVEN DOOR

The oven door can be removed and taken apart for cleaning. Make sure the oven and all its parts have cooled down before removing the door.

The oven door is heavy, take care while removing and refitting. Once the door is removed, place it on a soft, clean, flat surface.

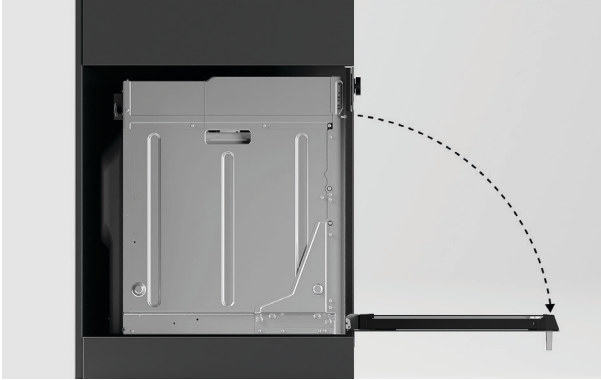

### Removing the oven door

1. Open the door fully.



2. Locate the hinge locks on either side of the door.

Push the locks upwards to release.



3. Holding the door on both sides, partially close the door and carefully pull the door away from the hinges.

## REMOVING THE OVEN DOOR

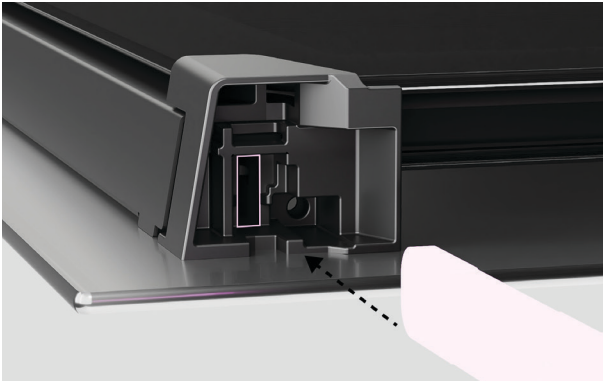

### Refitting the door

1. Holding the door on both sides, carefully lift door back onto the hinges.

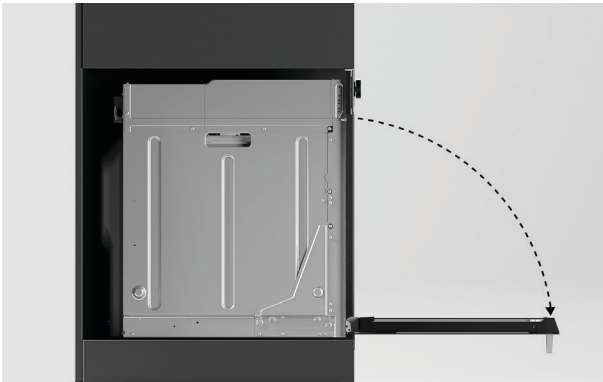

2. Open the door fully.

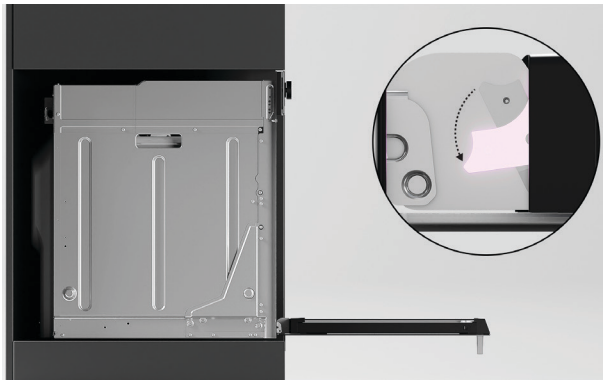

3. Push each locking lever down and lock into place.

Ensure both hinges are fully locked before closing the door.

## CLEANING THE OVEN DOOR

### Taking the door apart

The oven door is made up of multiple glass panes. The number of panes may vary depending on your model.

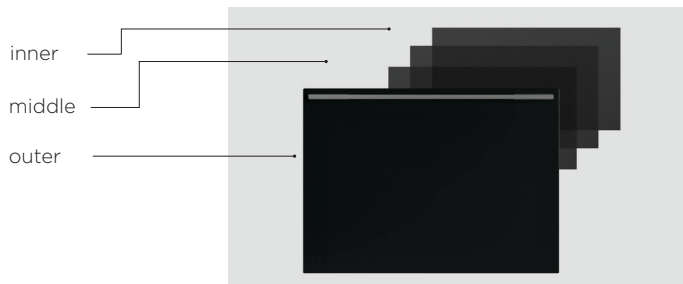

### Before you begin

- Follow the instructions carefully. Refitting the glass incorrectly may result in damage to the oven and could void your warranty. Do not use the oven without all glass correctly in place.
- Take care when handling the glass. Avoid bumping the corners or edges against any surface. This may result in the glass shattering.
- If you notice any sign of damage on any of the glass panes (such as chipping or cracks), do not use the oven. Contact a Fisher & Paykel trained and supported service technician or Customer Care.
- If the glass feels difficult to remove or replace, do not force it. Contact a Fisher & Paykel trained and supported service technician or Customer Care.

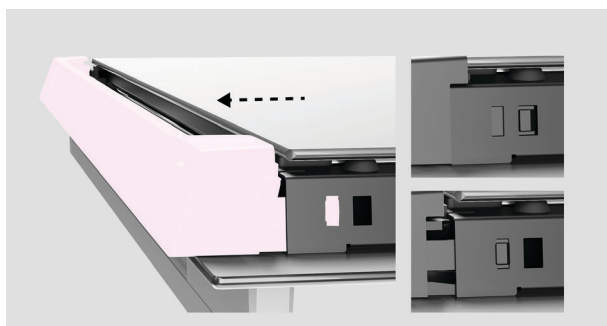

### Removing the inner pane

1. Push tabs on both sides of the glass retainer. Pull the retainer up until the tabs relocate in the uppermost hole.



2. Pull the pane toward the top of the door until clear of the brackets, then lift out.

Do not angle the pane too much as this may damage the glass.

## CLEANING THE OVEN DOOR

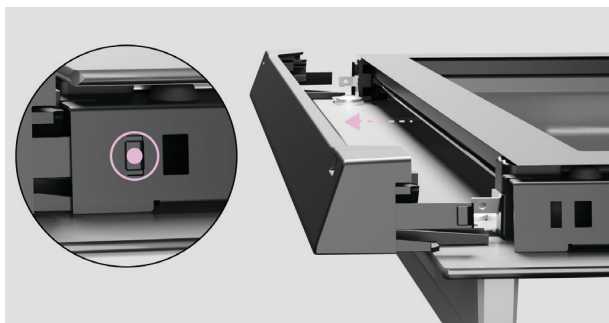

### Removing the middle panes

1. Push tabs on both sides of the glass retainer again and remove the retainer.

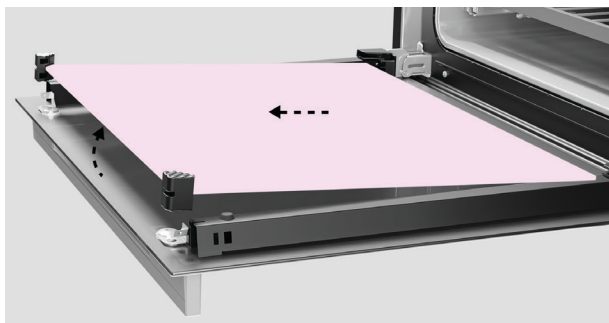

2. Pull pane towards the top of the door until clear of the brackets, then lift out.

The rubber stoppers should remain attached to the glass.

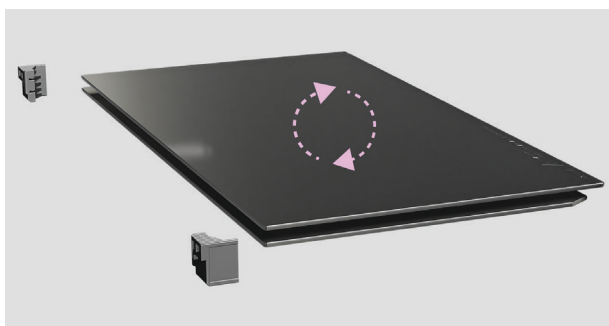

### Refitting the middle panes

1. Ensure the glass is the right way up before refitting.

The warning text at the bottom of the glass should face towards the front of the door.

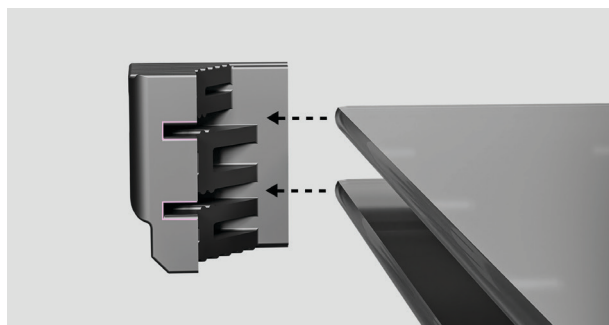

2. Ensure the rubber stoppers are attached to the glass and positioned correctly.

The longer side should be running down the side of the pane.

## CLEANING THE OVEN DOOR

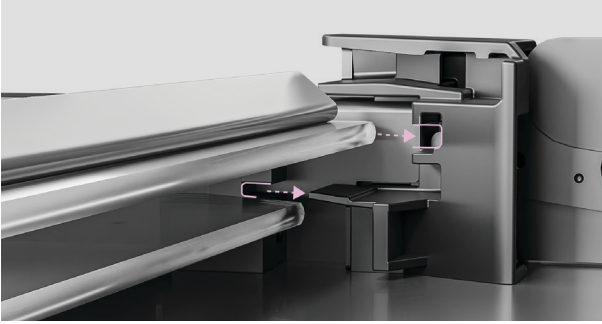

3. Slide the bottom of the glass into the lower brackets at the bottom of the door.



4. Lower the glass into place, with the rubber stoppers resting on the outer pane of glass.

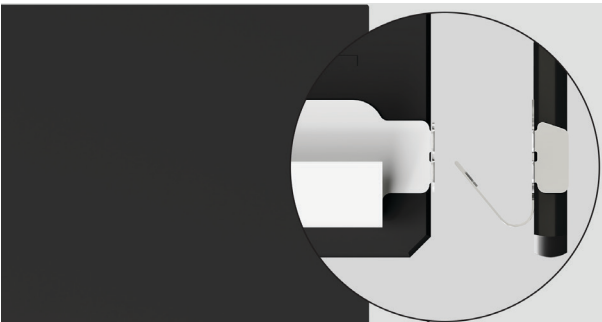

5. When replacing the second middle pane, ensure the metal bracket is still in place and correctly positioned at the bottom of the glass.

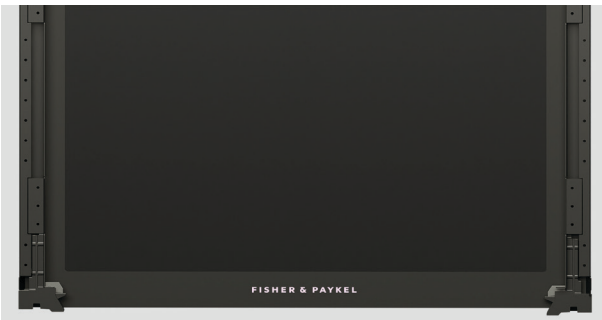

### Refitting the inner pane

1. Ensure the glass is the right way up before refitting.  
The logo should be readable at the bottom of the door.

## CLEANING THE OVEN DOOR

---



**2.** Slide the bottom of the pane into the upper brackets at the bottom of the door.

Lower the pane into place, resting on the brackets at the top of the door.

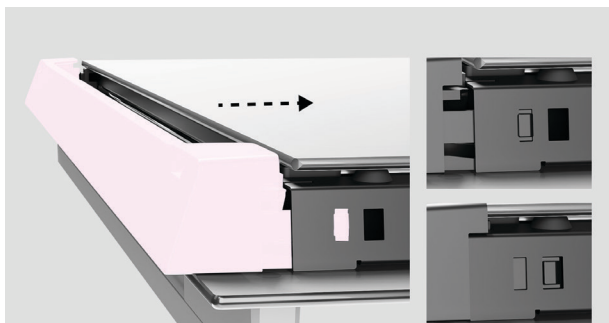

**3.** Replace the glass retainer, ensuring it clicks securely into place.

## STEAM CLEAN

To help lift stubborn spills, run the steam clean cycle before wiping out the oven. For best results, the oven should be around room temperature before beginning.

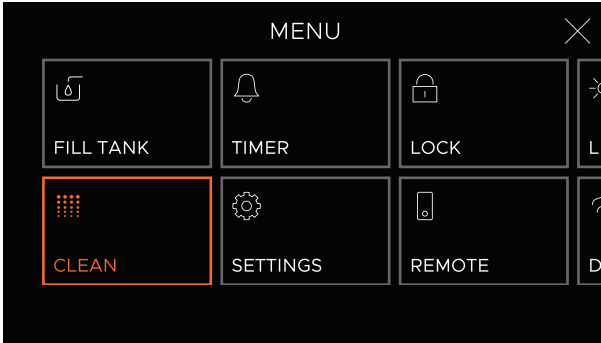

1. Go to the menu and select **CLEAN**.

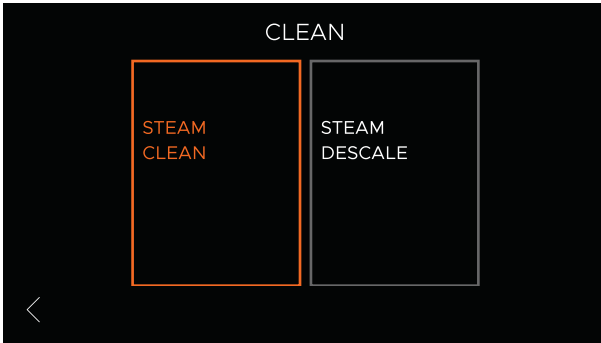

2. Select **STEAM CLEAN**, and follow the instructions onscreen.

## DESCALING

Descale your oven as soon as possible after the descale alert is shown. Failure to do this may cause the steam functions to become unusable.

### Making descaling solution

Add 80 grams (1/3 cup) of citric acid powder to 1 litre of warm water. Take care when handling citric acid. Ensure you follow the manufacturer's instructions.

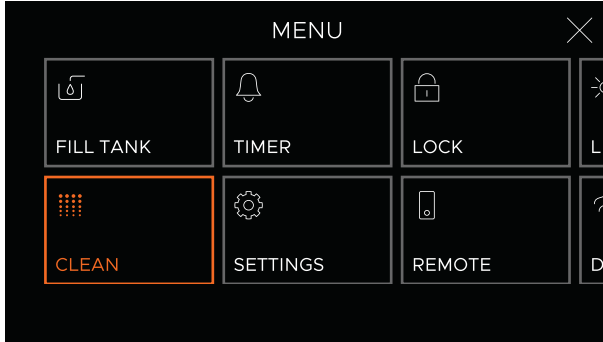

1. Go to the menu and select **CLEAN**.

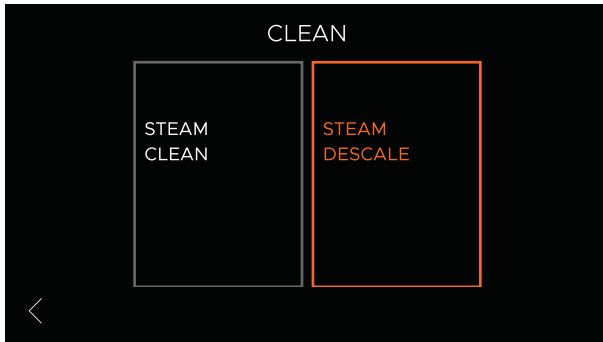

2. Select **STEAM DESCALE**, and follow the instructions onscreen.

After the Descale cycle is complete, wipe the base of the cavity to remove any excess moisture.

## DRY CYCLE

After running a steam function, there may be some moisture left in the oven. You can run a dry cycle to help remove the remaining moisture:

- Remove any food from the oven before starting a dry cycle.
- If the dry cycle is not run regularly, excess moisture may build up in the cavity and cause damage. Damage caused by not running the dry cycle may void your warranty.



1. Wait for the oven to cool, then wipe out the base of the cavity with a sponge or soft cloth before starting a dry cycle.

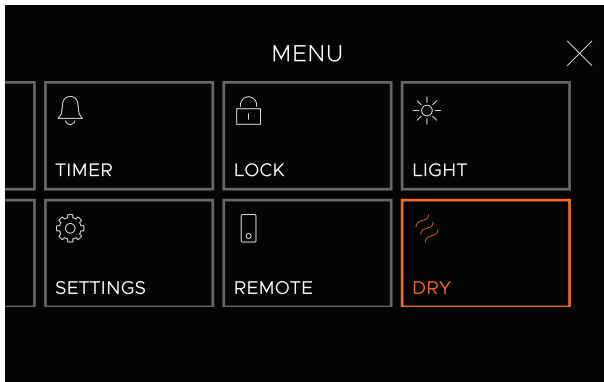

2. Go to the menu and select DRY.



3. Follow the instructions on screen to start the dry cycle.

# TROUBLESHOOTING

---

## General use

---

### Why will the product not turn on?

- No power. Make sure the product is connected to the power supply and switched on at the wall.
  - Check the circuit breaker, or check if there is a power cut in your home or area. If the product still won't turn on, call Customer Care or your Authorised Service Centre.
- 

### Why is the display not working?

- The controls may be locked. Press and hold the screen to unlock.
- 

### Why is the door opening slowly?

- For handleless ovens, the door may open slowly the first time it is used or after running a self clean cycle. The door should open normally the next time you open it.
- 

### Why isn't the oven heating up?

- If the oven is heating but not reaching the set temperature, the door may not be closed or sealing properly.
  - Ensure the door is closed properly and isn't being opened too often, or try removing and refitting the door. Refer to 'Removing the oven door' for instructions.
  - If the display is working but the oven is not heating at all, it may be in Demo mode. Call Customer Care or your Authorised Service Centre.
- 

### Why is there a minimum temperature I can set?

- For food safety reasons, the oven has factory set minimum temperature settings depending on the function or method selected. Try selecting a different function or method that is designed for lower temperatures.
- 

### Why is the fan running while the oven is heating?

- The fan will run as part of the preheating stage to help the oven get up to temperature quickly. Depending on the function or method selected, the fan will turn off after the oven has heated.
- 

### Why aren't the lights turning on when I open the door?

- The light bulb(s) may have blown. Refer to 'Replacing the oven lights'.
  - The door may not be closed or sealing properly.
  - Ensure the door is closed properly and isn't being opened too often, or try removing and refitting the door. Refer to 'Removing the oven door' for instructions.
-

## TROUBLESHOOTING

---

### **Why isn't the oven door straight?**

- The oven door has been fitted incorrectly. Try removing and refitting the door. Refer to 'Removing the oven door' for instructions.
- 

### **What do I do if the door glass is cracked, chipped or shattered?**

- Do not use the oven. Contact a Fisher & Paykel trained and supported service technician or Customer Care
- 

### **Why can't I access the oven settings?**

- The oven is on or set for automatic cooking.
  - You can only adjust settings while the oven is turned off. Try again after turning the oven off or after automatic cooking is complete.
- 

### **Why is there hot air blowing out of the vents after the oven has turned off?**

- The cooling fans will continue to run after the oven is turned off to ensure the oven cools properly. These will automatically turn off once the oven has cooled.
- 

### **Why isn't the steam tank compartment opening or closing?**

- The door may be open. Ensure the door is closed properly.
  - There might be something in the way. Check there are no obstructions stopping the compartment from opening or closing.
  - There may be a failure with the opening mechanism. If the problem persists contact a Fisher & Paykel trained and supported service technician or call Customer Care.
  - To close the compartment manually, firmly push the control panel with two hands back into place.
- 

### **Why does the screen say water level is too low when there is still water in the tank?**

- The tank needs a minimum amount of water in it to use steam cooking. Refill the tank to continue cooking with steam.
- 

### **Why does the screen say the tank isn't installed after I replace it?**

- The tank may not be fully back in place. Try removing and replacing it and ensure it is pushed fully into the compartment.
- 
-

## TROUBLESHOOTING

---

### Why is the fill tank button unavailable?

- The water tank compartment can't be accessed during some parts of the steam cooking process. Wait until the button becomes available again to refill the tank.
- 

### Why isn't the oven letting me know when the water tank is empty?

- The hose may be trapped under the level sensor in the water tank. Remove the water tank and adjust the hose.
- 

### Why can't I access steam cooking?

- The oven may need to be descaled. Follow the instructions onscreen or refer to 'Descaling'.
- 

### Why is the fill tank button unavailable?

- The water tank compartment can't be accessed during some parts of the steam cooking process. Wait until the button becomes available again to refill the tank.
- 

### Why does the oven make noises when cooking with steam?

- These are normal sounds made by the steam generator as it boils the water.
- 

### Why is there moisture building up in the oven during cooking?

- Steam and other cooking methods generate moisture. You can either run a dry cycle after cooking, or wait for the oven to cool and wipe dry.
- 

### Why is the drip tray overflowing?

- The drip tray needs to be cleaned or emptied. Wait for the oven to cool then wipe with a sponge or soft cloth, or lift up to remove and empty.
- 

### Why is there a water stain in the base of the oven?

- This can be caused by water hardness. Ensure the oven base is wiped clean regularly after cooking and before running a dry cycle.
- 

### Why is there a burnt smell coming from the oven?

- There may be food burnt onto the oven base. We recommend placing a solid tray below the perforated dish to prevent drips, and cleaning up any spills as soon as they happen. You can also run a steam clean cycle to help lift stubborn spills.
-

## TROUBLESHOOTING

---

---

### Why is the steam generator overheating?

- The hose may be trapped under the level sensor in the water tank. Remove the water tank and adjust the hose.
  - The oven may need to be descaled. Follow the instructions onscreen or refer to 'Descaling'.
  - The water hardness setting may be incorrect for the water hardness in your area. If you live in an area with hard water you may need to increase the water hardness level. Refer to 'Water hardness' for instructions.
-

## FAULT CODES

---

### How do I know if there is a problem?

Your oven will beep and an alert will show in the display.

### What to do

First try to fix the issue and clear the alert according to the instructions onscreen or the steps in the following table.

Do not turn the oven off at the wall unless it is completely cool. Turning off the power while the oven is too hot may damage the oven and its surrounding cabinetry.

### If the problem persists

- ① Note down the fault code.
- ② Contact Customer Care or a Fisher & Paykel trained and supported service technician. Refer to the Service and Warranty booklet for contact details.

If the fault code has disappeared, the fault has been reset and you can continue to use your oven.

FAULT CODE	POSSIBLE CAUSE	WHAT TO DO
<b>A1</b>	The oven has overheated.	<ul style="list-style-type: none"><li>• Allow the oven to cool down.</li><li>• Once the oven has cooled down and the door has unlocked, the alert code will disappear. You can now use the oven.</li></ul>
<b>F</b> + number	Technical fault.	<ul style="list-style-type: none"><li>• Note down the alert code.</li><li>• Wait until the cooling fans have stopped and the oven has completely cooled down.</li><li>• Turn the power to the oven off at the wall.</li><li>• Contact a Fisher &amp; Paykel trained and supported service technician or Customer Care.</li></ul>

---

## EUROPEAN DIRECTIVE 2012/19/EU ON WASTE ELECTRICAL AND ELECTRONIC EQUIPMENT (WEEE)

---

**EU** This appliance is marked according to the European Directive 2012/19/EU on Waste Electrical and Electronic Equipment (WEEE). By ensuring this product is disposed of correctly, you will help prevent potential negative consequences for the environment and human health, which could otherwise be caused by inappropriate handling of this product.

The symbol  marked on the serial plate, or on the documents accompanying the product, indicates that this appliance cannot be treated as household waste. It shall be handed over to the applicable collection point for the recycling of electrical and electronic equipment. Disposal of the appliance shall be carried out in accordance with the local environment regulations for waste disposal and ensure the refrigerant circuit is not damaged.

For more detailed information about treatment, recovery and recycling of this product, please contact your local city office, your household waste disposal service or your Fisher & Paykel retailer/dealer from whom you purchased this product.

## ENERGY GUIDELINES

### OS60S

WEIGHT (KG)	OVEN CAVITIES	CAVITY VOLUME (LITRES)	ENERGY CONSUMPTION* (CONVENTIONAL) KWH/CYCLE	ENERGY CONSUMPTION* (FAN FORCED) KWH/CYCLE	ENERGY EFFICIENCY INDEX (CONVENTIONAL)	ENERGY EFFICIENCY INDEX (FAN FORCED)
50	1	72	0.90	0.68	105	80
<b>STANDBY POWER** (WATTAGE)</b>			<b>TIME TO STANDBY*** (MINUTES)</b>			
0.5 W			15			

\*Energy consumption for electric cooking appliances is calculated using the following Standard: BS EN 60350 Part 1 - Ranges, ovens, steam ovens and grills – Methods for measuring performance.

\*\*Standby power for electric cooking appliances is calculated using the following Standard: EN 50564 - Electrical and electronic household and office equipment - Measurement of low power consumption.

\*\*\*Time to Standby for electric cooking appliances is calculated using the following Standard: EN 50643 - Electrical and electronic household and office equipment - Measurement of networked standby power consumption of edge equipment.

## SERVICE AND WARRANTY

---



### To access your Warranty and Service Guide

Scan the QR code with your smartphone to access your warranty and book a service, refer to your separate warranty and service book or view online at:

#### United Kingdom

<https://www.fisherpaykel.com/uk/help-and-support/warranty-information>

#### Ireland

<https://www.fisherpaykel.com/ie/help-and-support/warranty-information>

#### Europe

<https://www.fisherpaykel.com/eu/help-and-support/warranty-information>

This product has been designed for use in a domestic (residential) environment. This product is not designed for any commercial use. Any commercial use by the customer will affect this products Manufacturer's Warranty.

For spare parts, please contact Fisher & Paykel Customer Care. Spare parts are available for all Fisher & Paykel products for a minimum period of 10 years from the date of manufacture.

#### Complete and keep for safe reference:

Model \_\_\_\_\_

Serial No. \_\_\_\_\_

Purchase Date \_\_\_\_\_

Purchaser \_\_\_\_\_

Dealer \_\_\_\_\_

Suburb \_\_\_\_\_

Town \_\_\_\_\_

Country \_\_\_\_\_

## CUSTOMER CARE

---

### **Before you call for service or assistance**

Check the things you can do yourself. Refer to your full user guide and check:

- ① Your product is correctly installed.
- ② You are familiar with its normal operation.
- ③ You have read the 'Faults code' and 'Troubleshooting' sections.

If, after checking these points, you still need assistance or parts, please refer to your nearest Paykel trained and supported service technician, Customer Care, or contact us through our website [fisherpaykel.com](http://fisherpaykel.com).

### **In UK or Europe if you need assistance**

Call the Fisher & Paykel Customer Care Centre and talk to one of our Customer Care Consultants.

**Toll Free:** 08000 886 605

**Website:** [fisherpaykel.com](http://fisherpaykel.com)

#### **Postal address:**

Fisher & Paykel Appliances Ltd  
420 Cob Drive, Swan Valley  
Northampton NN4 9BB

### **In Ireland if you need assistance**

Call the Fisher & Paykel Customer Care Centre and talk to one of our Customer Care Consultants.

**Toll Free:** 1800 625174 or 01 807 7960

**Website:** [fisherpaykel.com](http://fisherpaykel.com)

#### **Postal address:**

Fisher & Paykel Appliances Ltd,  
Unit 2D Corporate Park,  
Swords Dublin

### **If you need service**

Fisher & Paykel has a network of Fisher & Paykel trained and supported service technicians that can carry out any service necessary on your appliance. Our Customer Care Centre can recommend a Fisher & Paykel trained and supported service technician in your area, or you can book one online at [fisherpaykel.com](http://fisherpaykel.com).

If you call, write or contact us via our website please provide:

your name and address, model number, serial number, date of purchase and a complete description of the problem. This information is needed in order to better respond to your request for assistance.

**Product details can be found inside the oven behind the control panel**

**FISHERPAYKEL.COM**

© Fisher & Paykel Appliances 2025. All rights reserved.

The models shown in this guide may not be available in all markets  
and are subject to change at any time.

The product specifications in this guide apply to the specific products and  
models described at the date of issue. Under our policy of continuous product  
improvement, these specifications may change at any time.

For current details about model and specification availability in your country,  
please go to our website or contact your local Fisher & Paykel dealer.

**432155B 09.25**