

The Haier logo is displayed in white text on a dark grey rectangular background in the top right corner of the page.

Haier

# Oven, 60cm, 14 Function, Self-cleaning with Air Fry

---

HWO60S14TPB6 and HWO60S14TPX6



## CONTENTS

---

Safety and warnings .....	5
Product overview .....	10
Control panel .....	11
First use .....	12
Using the oven .....	14
Cooking functions .....	17
Wi-Fi connection and remote mode .....	20
Care and cleaning .....	21
Replacing the lights .....	26
Troubleshooting .....	27
Manufacturer's warranty .....	28
Customer service .....	30



**⚠ WARNING!**



**Electric Shock Hazard**

Failure to follow this advice may result in electric shock or death.

- Do not cook on a broken or cracked cooktop. If the cooktop surface should break or crack, switch the appliance off immediately at the mains power supply (wall switch) and contact a qualified technician.
- Switch the appliance off before cleaning or maintenance.

**⚠ WARNING!**



**Fire Hazard**

Failure to follow this advice may result in serious burns or death.

- Unattended cooking on a hob with fat or oil can be dangerous and may result in fire.
- Cover flame, eg with a lid or fire blanket, or use dry chemical or foam-type extinguisher.
- Do not store items on cooking surfaces.

**⚠ WARNING!**



**Cut Hazard**

Failure to follow this advice could result in injury and cuts.

- The razor sharp blade of a cooktop scraper is exposed when the safety cover is retracted. Use with extreme care and always store safely and out of the reach of children.

**⚠ WARNING!**



**Hot Surface Hazard**

**Failure to follow this advice could result in burns and scalds.**

- Do not touch surface units or areas near units. Surface units maybe hot even though they are dark in colour.
- Surfaces of the appliance may become hot enough to cause burns.
- During and after use, do not touch or let clothing or other flammable materials contact heating elements until they have had sufficient time to cool.
- Handles of saucepans may be hot to touch. Check saucepan handles do not overhang other cooking zones that are on. Keep handles out of reach of children.
- Never leave metal objects (such as kitchen utensils) or empty pans on the cooktop as they can become very hot quickly.

# SAFETY AND WARNINGS

---

## READ AND SAVE THIS GUIDE

Only use the oven for its intended purpose, that is only for the cooking of foods: any other use, for example as a heat source, is considered improper and therefore dangerous. The manufacturer cannot be held responsible for any damage resulting from improper, incorrect or unreasonable usage.

### General warnings

- Do not use a steam cleaner for cleaning operations.
- **CAUTION:** in order to avoid a hazard due to inadvertent resetting of the thermal cut-out, this appliance must not be supplied through an external switching device, such as a timer, or connected to a circuit that is regularly switched on and off by the utility.
- During use the appliance become hot. Care should be taken to avoid touching heating elements inside the oven.

### Use limitations

- The appliance can be used by children aged from 8 years and above and persons with reduced physical, sensory or mental capabilities or lack of experience and knowledge if they have been given supervision or instruction concerning use of the appliance in a safe way and understand the hazards involved. Children shall not play with the appliance. Cleaning and maintenance shall not be made by children without supervision.
- This appliance is not intended to be used by persons (including children) with reduced physical, sensory or mental capabilities, or lack of experience and knowledge, unless they have been given supervision or instruction concerning use of the appliance by a person responsible for their safety.
- Children should be supervised to ensure that they do not play with the appliance.
- **WARNING:** the appliance and its accessible parts become hot during use. Care should be taken to avoid touching heating elements.
- Children less than 8 years of age shall be kept at away unless continuously supervised.
- **WARNING:** Accessible parts may become hot during use. Young children should be kept away.

### Installation warnings

- The oven can be located high in a column or under a worktop.
- Before fixing, you must ensure good ventilation in the oven space to allow proper circulation of the fresh air required for cooling and protecting the internal parts. Make the openings specified on the illustrations according to the type of fitting. Always fix the oven to the furniture with screws provided with the appliance.
- No additional operation/setting is required in order to operate the appliance at the rated frequencies.
- The appliance must not be installed behind a decorative door in order to avoid overheating.
- During installation the oven should be disconnected from the mains electricity supply.
- If the assistance of the manufacturer is required to rectify faults arising from incorrect installation, this assistance is not covered by the guarantee. The installation instructions for professionally qualified personnel must be followed.
- Incorrect installation may cause harm or injury to people, animals or belongings. The manufacturer cannot be held responsible for such harm or injury.
- Installation must be carried on by a qualified technician who must know and respect the laws in force in the country of installation and the manufacturer's instruction.
- After unboxing the appliance, always check it is not damaged, in case of issue contact the customer service before installing and do not connect to the power supply.
- Remove the packaging material before operating the appliance.
- During installation do not use the oven door's handle to lift and move the oven.
- The installation furniture and the adjacent ones must with stand temperatures of 95°C.

## SAFETY AND WARNINGS

---

- Do not install the product in open environments exposed to atmospheric agents.
- This appliance is designed to be used at altitude lower than 2000m.
- It is recommended to wear protective gloves during installation to avoid cut injuries.
- Do not install the product in open environments exposed to atmospheric agents.

### Electrical warnings

- The socket must be suitable for the load indicated on the tag and must have ground contact connected and in operation. The earth conductor is yellow-green in colour. This operation should be carried out by a suitably qualified professional.
- Connection to the power source can be made by plug or by fixed wiring placing an omnipolar breaker, with contact separation compliant to the requirements for overvoltage category III, between the appliance and the power source that can bear the maximum connected load and that is in line with current legislation.
- In case of incompatibility between the socket and the appliance plug, ask a qualified electrician to substitute the socket with another suitable type. The plug and the socket must be conformed to the current norms of the installation country.
- The yellow-green earth cable should not be interrupted by the breaker. The socket or omnipolar breaker used for the connection should be easily accessible when the appliance is installed.
- If the supply cord is damaged, it must be replaced by the manufacturer, its service agent or similarly qualified persons in order to avoid a hazard. For any repairs, refer only to the Customer Care Department and request the use of original spare parts.
- Disconnect the appliance from the mains electricity supply before carrying out any work or maintenance on it.
- **WARNING:** ensure that the appliance is switched off before replacing the bulb, to avoid the possibility of electric shocks.
- The oven must be switched off before removing the removable parts. After cleaning, reassemble them according the instructions.
- The use of any electrical appliance implies the observance of some fundamental rules:
  - do not pull on the power cable to disconnect the appliance from the power source;
  - do not touch the appliance with wet or damp hands or feet;
  - in general the use of adaptors, multiple sockets and extension cables is not recommended;
  - in case of malfunction and/or poor operation, switch off the appliance and do not tamper with it.
- **NOTE:** as the oven could require maintenance work, it is advisable to keep another wall socket available so that the oven can be connected to this if it is removed from the space in which it is installed.
- Any repair, installation and maintenance not carried out correctly can seriously endanger the user.
- The manufacturing company hereby states that it does not assume any responsibility for direct or indirect damages caused by incorrect installation, maintenance, or repair work. Furthermore, it is not liable for damages caused by the absence or interruption of the grounding system (e.g. electric shock).
- **CAUTION:** in order to avoid a hazard due to inadvertent resetting of the thermal cut-out, this appliance must not be supplied through an external switching device, such as a timer, or connected to a circuit that is regularly switched on and off by the utility.
- The appliance is not designed to be activated by an external timer or separate remote control system.

## SAFETY AND WARNINGS

---

### Use and maintenance

- Wash all accessories before first use with a solution of hot water and washing up liquid.
- The dripping pan collects the residues that drip during cooking.
- When you place the grid or air fry tray on the side racks, make sure that the shorter section of the side (between the stop and the extremity) is directed towards the interior of the oven. If the grid has a decorative metal bar, pay attention to position it on the exterior of the oven so that the brand logo can be visible and readable. For the correct positioning refer also to the image in the Accessories section of this user manual.
- Do not use harsh abrasive cleaners or sharp metal scrapers to clean the oven door glasses, since they can scratch the surface, which may result in shattering of the glass.
- Only use the temperature probe recommended for this oven.
- During cooking, moisture may condense inside the oven cavity or on the glass of the door. This is a normal condition. To reduce this effect, wait 10-15 minutes after turning on the power before putting food inside the oven. In any case, the condensation disappears when the oven reaches the cooking temperature.
- Cook the vegetables in a container with a lid instead of an open tray.
- Avoid leaving food inside the oven after cooking for more than 15/20 minutes.
- A long power supply failure during an occurring cooking phase may cause a malfunction of the monitor. In this case contact customer service.
- **WARNING:** Do not line the oven walls with aluminium foil or single-use protection available from stores. Aluminium foil or any other protection, in direct contact with the hot enamel, risk melting and deteriorating the enamel of the insides.
- **WARNING:** Never remove the oven door seal.
- **CAUTION:** Do not refill the cavity bottom with water during cooking or when the oven is hot.
- For a correct use of the oven it is advisable not to put the food in direct contact with the racks and trays, but to use oven papers and/or special containers.
- **WARNING:** Risk of burn and damage to the appliance: Using the steam function the released steam can cause burns: Open the door carefully to avoid injury after using a cooking function with steam.
- Use only drinking water to fill in the cavity bottom during the steam function.

### Warnings (\*for Pyro ovens)

- Excess spillage must be removed before cleaning.
- **WARNING:** before initiating the automatic cleaning cycle:
  - Clean the oven door;
  - Remove large or coarse food residues from the inside of the oven using a damp sponge. Do not use detergents;
  - Remove all accessories and the sliding rack kit (where present);
  - Do not place tea towels .
- In ovens with meat probe it is necessary, before making the cleaning cycle, close the hole with the nut provided. Always close the hole with the nut when the meat probe is not used.
- During the pyrolytic cleaning process (if available), the surfaces may get hotter than usual and children should be kept away.
- If a hob has been fitted above the oven, never use the hob while the Pyrolizer is working, this will prevent the hob from overheating.

## PRODUCT OVERVIEW

---

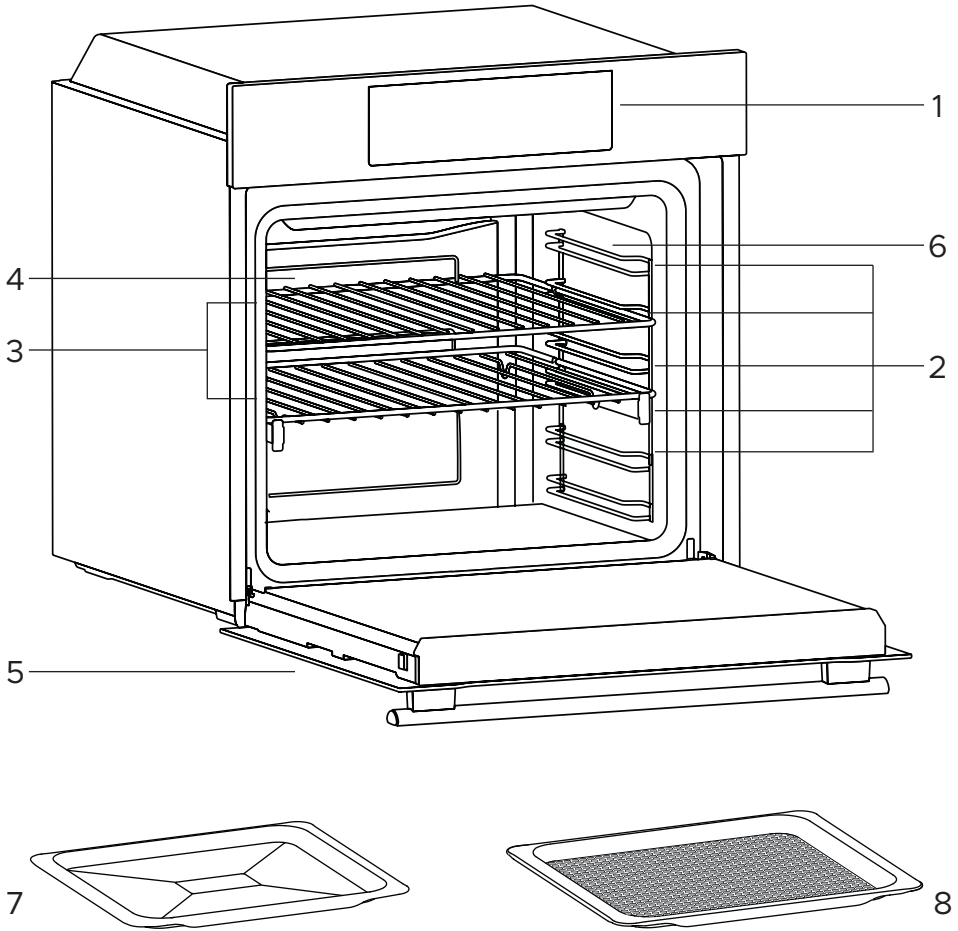

---

### FEATURES AND ACCESSORIES

---

1 Control panel

---

2 Shelf positions

---

3 Racks

---

4 Fan cover

---

5 Oven door

---

6 Side racks

---

7 Baking tray

---

8 Airfry tray

---

## CONTROL PANEL

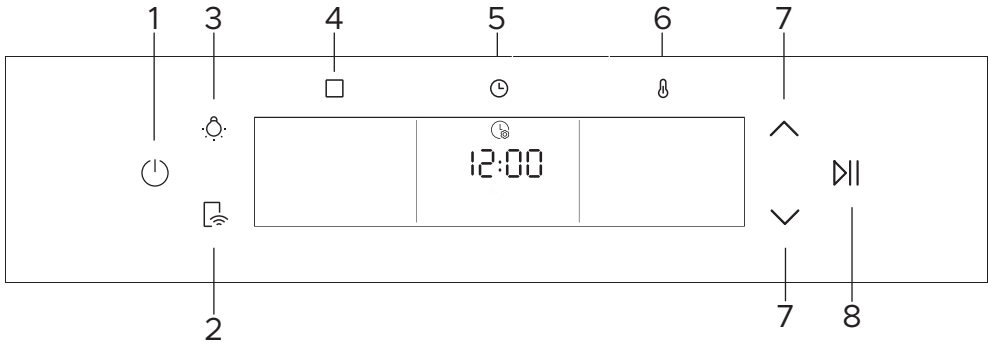

1	<b>POWER</b>	Press to turn oven ON/OFF.
2	<b>REMOTE MODE</b>	Press and hold to use Remote Mode after connecting the oven with the app.
3	<b>LIGHT</b>	Press to turn lights ON/OFF.
4	<b>FUNCTIONS</b>	Press to access cooking functions, recipes, cleaning functions and settings.
5	<b>TIME</b>	Press to access clock, cooking duration, timer and delayed start modes.
6	<b>TEMPERATURE</b>	Press to check oven temperature or activate FAST PREHEAT.
7	<b>SCROLL</b>	Press to cycle through functions and adjust settings.
8	<b>START/PAUSE</b>	Press to START/PAUSE cooking and confirm functions.

# FIRST USE

## Preparing your oven

Before using your oven for the first time, remove and wash all accessories, and clean the inside of the oven with a damp, soft cloth and mild detergent. Wipe the outside with a damp, soft cloth. Dry with a clean cloth.

Run the empty oven at maximum temperature for 60 minutes to remove the newness smell. See 'Using the oven'. The oven may smoke slightly during this process. This is normal.

## Settings

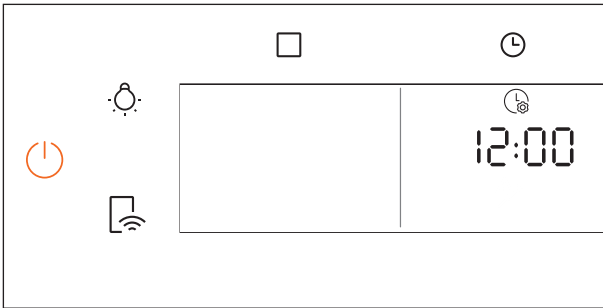

The first time you switch on the oven, you will be prompted to set the clock, display brightness and alert volume level.





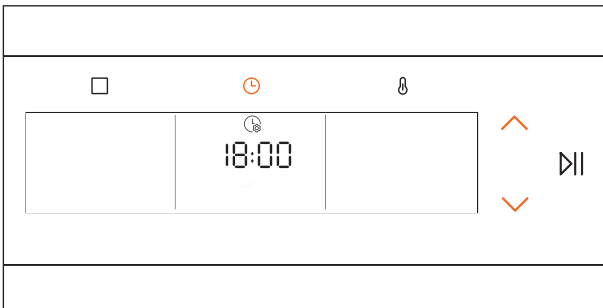

### Setting the clock

1. Press  to turn the oven on.

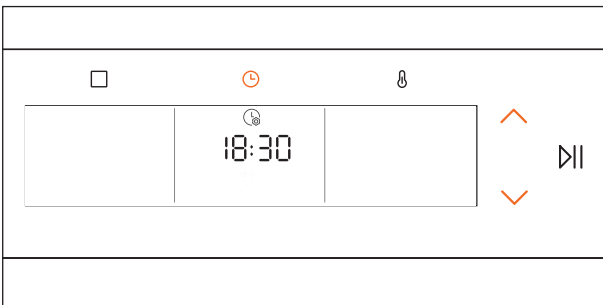

2. Press  or  to set the hour.  
Press  to confirm.



3. Press  or  to set the minutes.  
Press  to confirm.

## FIRST USE

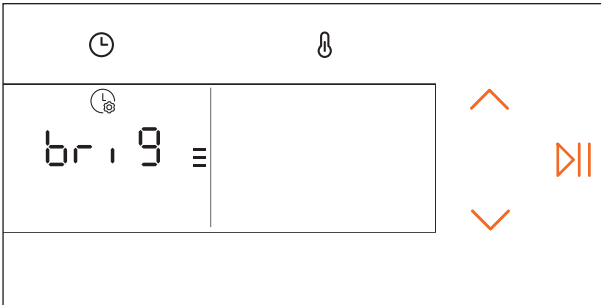

### Setting the display brightness

Press  $\vee$  or  $\wedge$  to set the brightness level.

Press  $\triangleright$  to confirm.

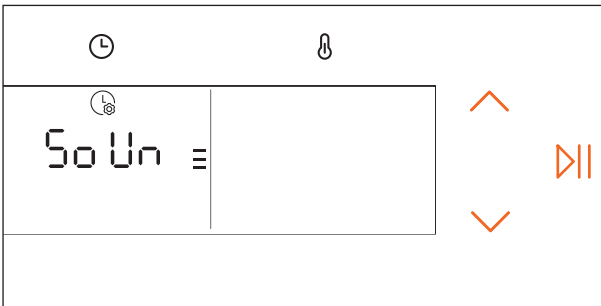

### Setting the alert volume level

Press  $\vee$  or  $\wedge$  to set the volume level.

Press  $\triangleright$  to confirm.

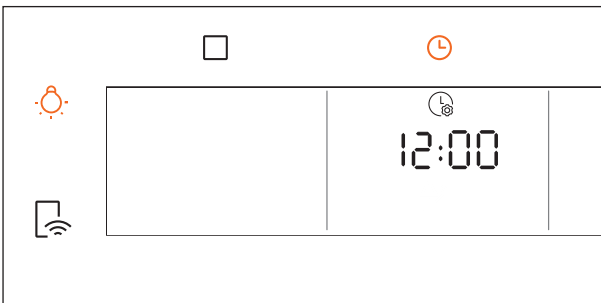

### Resetting clock, brightness and volume



Press and hold  $\text{☰}$  to access and reset clock, brightness and volume settings.

Press  $\vee$  or  $\wedge$  to adjust,  $\text{🕒}$  to confirm time and  $\triangleright$  to confirm brightness and volume.

## USING THE OVEN



### Functions menu

Press  as required to access the **FUNCTIONS** menu and cycle through the menu items.

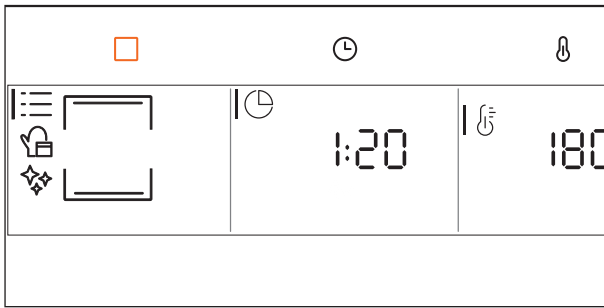

	<b>COOKING FUNCTIONS</b>	Access cooking functions.
	<b>EVERYDAY COOKING</b>	Access preset cooking programs.
	<b>CLEANING FUNCTIONS</b>	Access cleaning functions.



### Selecting a cooking function

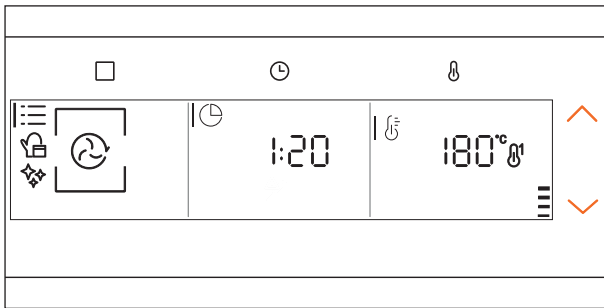



1. Press  to access the **FUNCTIONS** menu and select **COOKING FUNCTIONS**: .

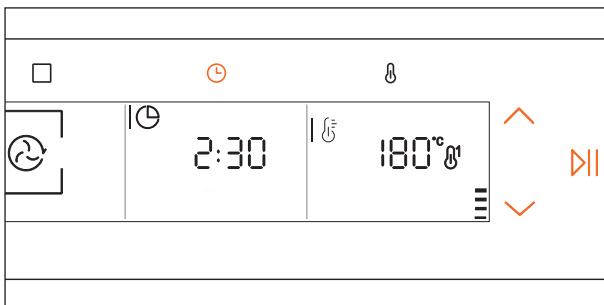

2. Press  or  to scroll through the **COOKING FUNCTIONS** menu and select the desired cooking function.



### Setting cooking duration

Press  to select **COOKING DURATION** , then  or  to set the duration. Press  to start preheat (if available).

Press  to start the countdown after preheating.

## USING THE OVEN

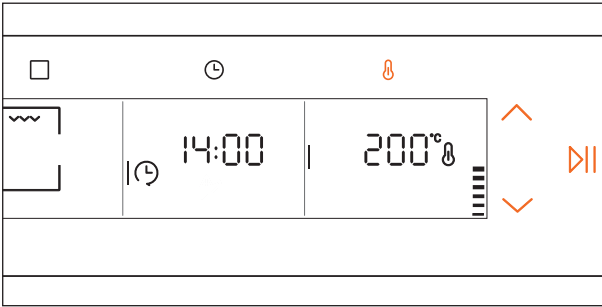

### Setting the temperature

Press twice to select **TEMPERATURE VALUE**, then or to set or adjust the temperature. Press to confirm.

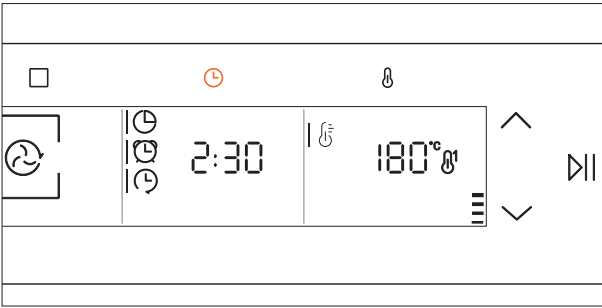

### Accessing the time menu

Press to access the time menu and cycle through the options:

- **COOKING DURATION**
- **TIMER**
- **DELAYED START**

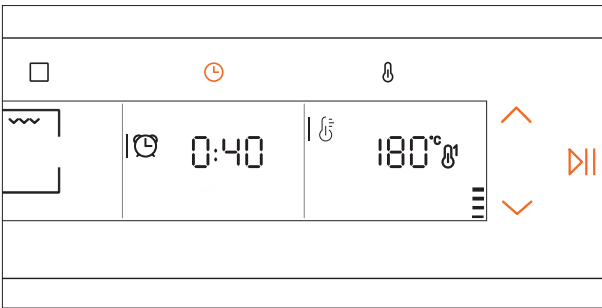

### Setting the timer

Press to select **TIMER** then or to set the duration. Press to confirm.

The timer operates independently from cooking functions. Cooking will continue until the oven is turned off.

**TIMER** can also be used when the oven is in standby.

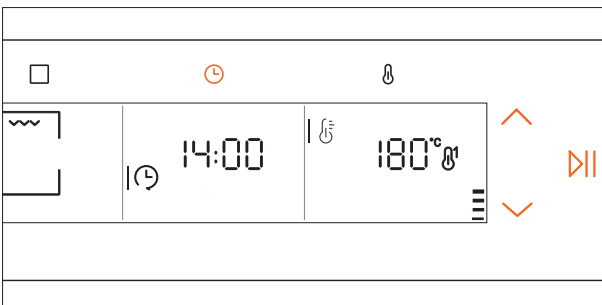

### Delayed start

After setting a cooking duration, you can schedule a time for cooking to start.

Press to select **DELAYED START** then then or to set a cooking start time. Press to confirm.

Not available with **MAXI GRILL** or **FAN MAXI GRILL** function.

## USING THE OVEN

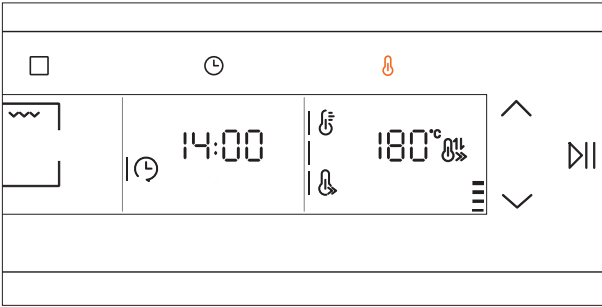

### Accessing temperature menu

Press to access the temperature menu and cycle through the options:

- PREHEAT
- TEMPERATURE VALUE
- FAST PREHEAT

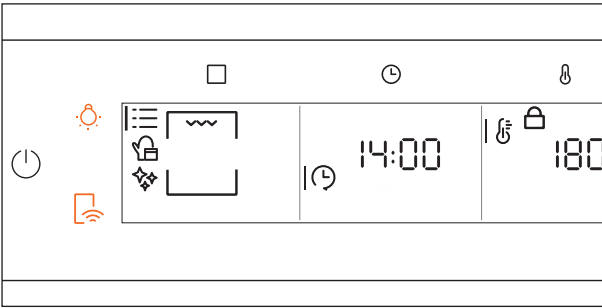

### LOCK

Press and hold and to activate LOCK. Press and hold again to unlock.





## COOKING FUNCTIONS

### Preheating the oven







Ensure you remove all accessories from the oven before using functions that have a preheating stage.

### Fast preheating

**FAST PREHEAT** combines fan and heating elements to preheat the oven, without using the cavity light, to heat the oven faster and save energy. Not available with all functions.

ICON	FUNCTION	DEFAULT TEMP°C / TEMP°C RANGE	SUGGESTED SHELF POSITION	PREHEAT	COOKING SUGGESTIONS
	Bake	200°C 30–250°C	L2/3	Yes/Fast preheat	Ideal for cakes, breads, biscuits, quiches on one level using both upper and lower level heating.
	Fan Bake	175°C 50–250°C	L2/3/4	Yes/Fast preheat	Ideal for roasts, casseroles, vegetables and pies with moist fillings on one level. Ideal for cooking foods with high water content.
	Fan Forced	160°C 50–250°C	L4 (one tray) L2+L5 (two trays) L2+L4+L6 (three trays)	Yes/Fast preheat	Ideal for cakes, biscuits and pizzas on one or more levels.
	Air Fry	200°C 150–250°C	L3/4	No	Ideal for preparing frozen foods or breaded par-cooked foods which are usually fried. Thanks to the dedicated tray, the hot air can flow evenly over the foods.
	Pizza	300°C 200–300°C	L2/3	No	Ideal for all kinds of pizzas without preheating the oven. Use lower temperatures for frozen items and 300°C for homemade pizza.

## COOKING FUNCTIONS





ICON	FUNCTION	DEFAULT TEMP°C / TEMP°C RANGE	SUGGESTED SHELF POSITION	PREHEAT	COOKING SUGGESTIONS
	<b>Maxi grill</b>	1-5	L6 for thin foods, L5 for thicker foods	No	<p>Ideal for sausages, steaks and toast.</p> <p>The entire area below the grill element becomes hot. Use with the door closed. Turn food two thirds of the way through cooking (If necessary).</p>
	<b>Fan maxi grill</b>	200°C 150-250°C	L4/L5	Yes/Fast preheat	<p>Ideal for larger cuts of meat or fish that require longer cooking without burning the top. The entire area below the grill element becomes hot. Use with the door closed. Turn food two thirds of the way through cooking (If necessary).</p>
	<b>Traditional Bake</b>	170°C 50-230°C	L2	Yes/Fast preheat	<p>Ideal for traditional recipes and foods that have a pastry base and require delicate baking or minimal surface browning.</p>
	<b>Bakery + Steam</b>	210°C 190-220°C	L2/L3	No	<p>Ideal for breads, lasagne and pastries. Can be used with Steam Assist by adding 100mL of water to base of oven cavity.</p>
	<b>Roast</b>	200°C 150-250°C	L2/3/4	Yes/Fast preheat	<p>Ideal for roasting meats, poultry and fish by using all elements and the fan. This provides even cooking and enhanced browning.</p>
	<b>Defrost</b>	20°C	L3	No	<p>Fan circulates air around food at room temperature to accelerate defrosting of frozen food.</p>

## COOKING FUNCTIONS

### Everyday cooking

These programmed recipe functions allow you to cook a variety of recipes without preheating the oven. You can adjust cooking duration and temperature within the ranges listed in the table.

If further cooking is required after using these functions, we recommend using a standard cooking function instead of resetting an everyday cooking function.

ICON	FUNCTION	DEFAULT TEMP °C / TEMP °C RANGE	SUGGESTED SHELF POSITION	PREHEAT	COOKING SUGGESTIONS
	White meat	190°C 180–200°C	L2/3/L4	No	Ideal for poultry and cuts of white meat. Time range: 40–80 mins.
	Red meat	190°C 180–200°C	L3/L4	No	Ideal for beef, and cuts of red meat. Time range: 20–80 mins.
	Fish	170°C 160–180°C	L3/L4	No	Ideal for whole fish and fillets. Time range: 15–45 mins.
	Vegetables + Steam	190°C 180–200°C	L3/L4	No	Ideal for roasted vegetables and potatoes. Can be used with Steam Assist by adding 180mL of water to base of oven cavity. Time range: 30–80 mins.

## WI-FI CONNECTION AND REMOTE MODE

Your appliance may be connected to your home wireless network and operated remotely using the app. Connect your appliance to ensure it stays up to date with the latest software and features.

### Getting started





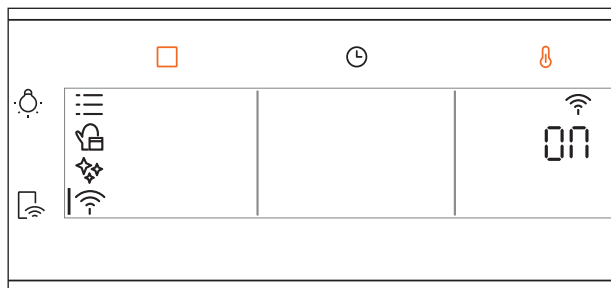

- Ensure your home Wi-Fi network and Bluetooth on your mobile device are turned on.
- You will be given step-by-step guidance on your appliance and mobile device.
- It may take up to 10 minutes to connect your appliance.

On your mobile device:

- 1 Download the app from [www.haier.co.nz/smart](http://www.haier.co.nz/smart).
- 2 Register and create an account.
- 3 Add your appliance and set up the Wi-Fi connection.



### Connecting to Wi-Fi

Press Functions  to select Wi-Fi settings , then press  and use  or  to turn Wi-Fi .

Follow the instructions in the app to complete setup.

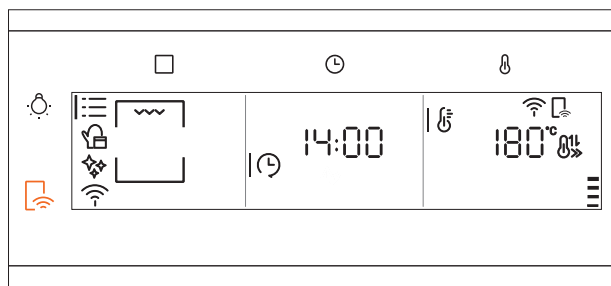



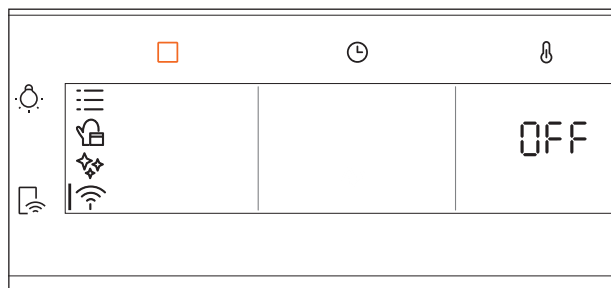

### Turning Remote Mode ON/OFF

Press and hold  until the Remote Mode icon  shows on the display.

Press and hold  again to turn off Remote Mode.



### Disconnecting or resetting Wi-Fi

Press Functions  to reach Wi-Fi settings , then press  or  until **OFF** or  shows on the display.

## CARE AND CLEANING

### General recommendations

We recommend cleaning the oven after each use. Wait for the oven to cool before cleaning.

- Do not line the oven walls with aluminium foil or single-use protection as these may damage the enamel interior.
- Frequent cooking at high temperatures can produce more food residue in the oven and result in strong smoky smells. Where possible, we recommend longer cooking durations at lower temperatures.
- We recommend you only use the accessories supplied with the oven and dishes and baking moulds resistant to very high temperatures.

### Pyrolytic cleaning



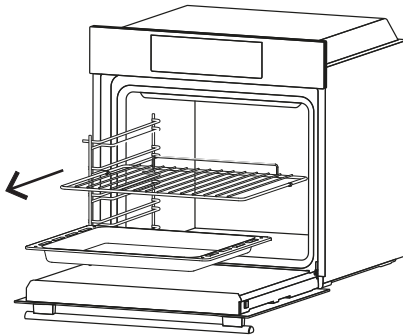

The pyrolytic cleaning cycle rapidly heats the oven to 410°C to clean the interior by turning food residue to dust. Once the oven has cooled, wipe the interior clean with a damp cloth and mild detergent.

The oven door will remain locked until the cleaning cycle and cooling phase are complete.



1. Remove all racks, trays and side racks from the oven.



2. Press Functions  as required to access CLEANING FUNCTIONS . Press  or  to select PYROLYTIC CLEAN .



3. Press  to start cleaning process.  
Allow the function to operate for the preset duration. Wait for the oven to cool completely before wiping the interior clean with a soft, damp cloth.

## CARE AND CLEANING



### Hydro clean

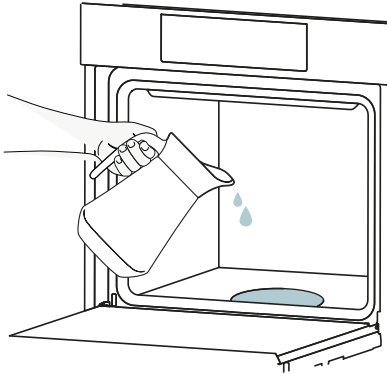

This function uses steam to clean light levels of residue from the oven interior in a quick and eco-friendly way. Always use distilled or drinkable water.

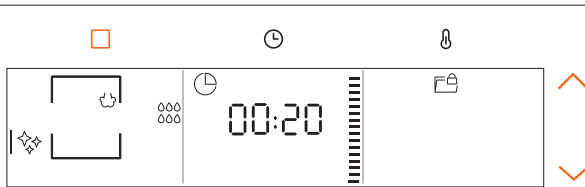

1. Remove all racks, trays and side racks from the oven, then pour 100 ml of water into the base of the oven.



2. Press  as required to access the FUNCTIONS menu and select CLEANING FUNCTIONS .

Press  or  to select HYDRO CLEAN .



3. Press  to start the cleaning process.

Allow the function to operate for the preset duration. Wait for the oven to cool completely before wiping the interior clean with a soft, damp cloth.

## CARE AND CLEANING

### Cleaning the accessories

We recommend you clean and dry the accessories thoroughly after every use. If required, soak them for 30 minutes in a mixture of hot water and mild detergent before cleaning.

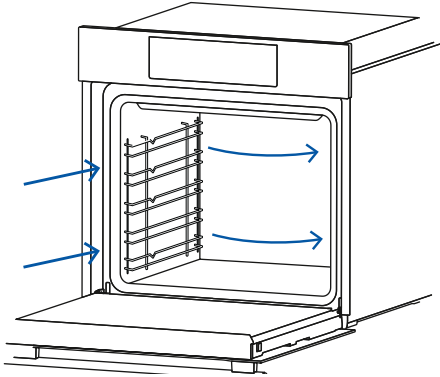

### Cleaning the side racks

1. Push the side racks towards the back of the oven, then pull to the centre to remove.

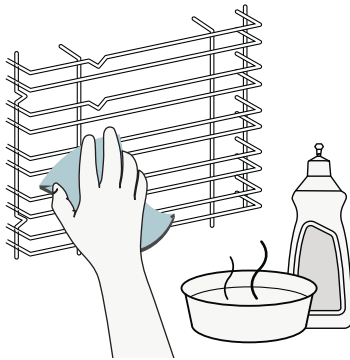

2. Wipe the side racks clean with a soft, damp cloth and mild detergent. Dry with a clean cloth.

Side racks are also dishwasher safe.

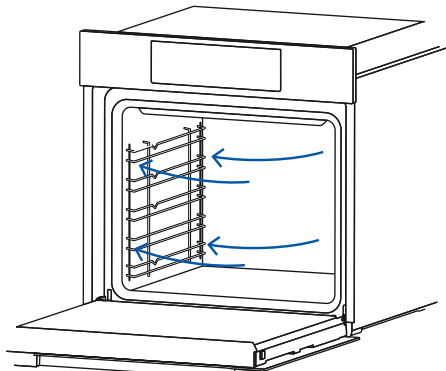

3. Push the racks back into the side of the oven to refit.

## CARE AND CLEANING

### Removing the door

The door can be removed for greater access when cleaning the oven.

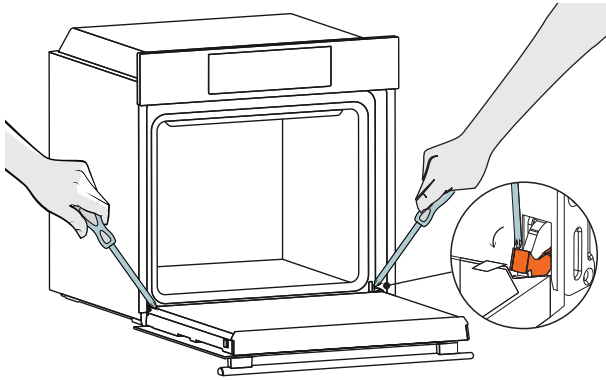

1. Open the door fully and use a screwdriver to rotate the hinge locks outwards, then carefully lift the door off and place it on a soft, level surface.

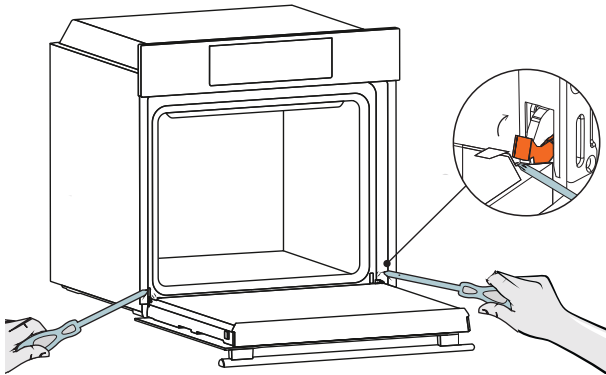

2. To refit, place door back onto the hinges and use a screwdriver to rotate the hinge locks back into the hinge cavity.

## CARE AND CLEANING

### Removing and cleaning the door glass

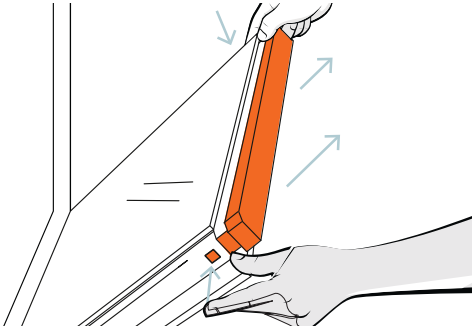

1. Shut the door halfway, then press the buttons on both sides of the door at the same time to release the cover on top of the door.



2. Carefully remove the inner and middle panes and wipe clean with a soft, damp cloth and mild detergent.

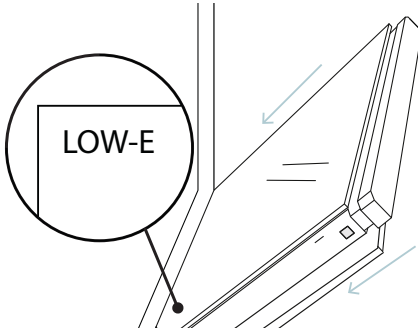

3. Once clean, carefully refit the panes and ensure the 'LOW-E' label of the middle pane, and the 'PYRO' label of the inner pane, are positioned correctly in the lower left-side corner of the door.

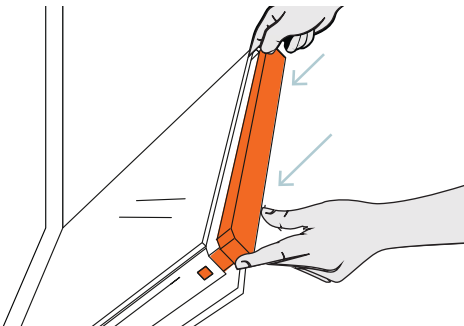

4. Push the cover back onto the top of the door until you hear the buttons click.

## REPLACING THE LIGHTS

---

Always disconnect the oven from the power supply before replacing the lights.

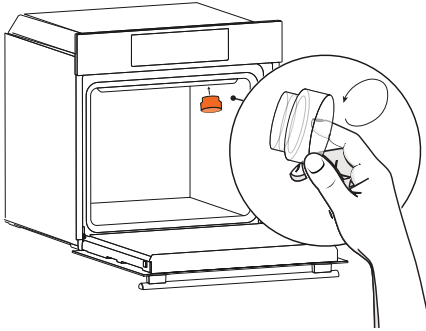

### Replacing the back light

1. Turn the protective light cover clockwise to remove it.

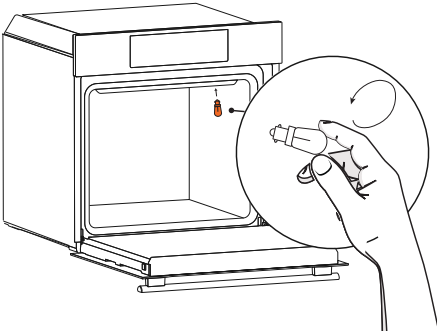

2. Unscrew the light bulb to remove it. Replace with a new bulb and refit the protective cover.

## TROUBLESHOOTING

PROBLEM	POSSIBLE CAUSES	WHAT TO DO
<b>Er__ is showing on the display</b>	There is an error.	If the oven is switched on, switched it off and wait several minutes before powering it on again. If the error has disappeared, you can continue to use the oven. If the error code remains, note the number and call Customer Service.
<b>The oven does not work</b>	No power.	Check that the mains power supply (wall switch) is turned on, the fuse has not tripped and there is no power outage in your area.
<b>The lights are not operating when I open the oven door</b>	The lights are turned off.	Press  to turn the lights on.
	The oven lights have blown.	Replace the lights. See 'Replacing the lights.'
<b>The oven is not heating</b>	The door is not fully closed.	Make sure the door is properly closed. The heating elements are disabled while the door is open.
	The door has been opened too often during cooking.	Avoid opening the door too often during cooking.
<b>A glass pane in the door has cracked, chipped or shattered</b>	The glass has been knocked or cleaned incorrectly.	You must NOT use the oven. Call your Authorised Repairer or Customer Service.
<b>The controls aren't working</b>	The control panel is locked.	Press and hold the  and  to unlock.
<b>Hot air is coming out of the vents when the oven is off</b>	The cooling fan is running.	This is normal. You do not need to do anything.
<b>The fan comes on when I select a function that does not use a fan (eg. BAKE)</b>	The fan starts automatically while preheating (but not for FAST PREHEAT).	This is normal. The fan will turn off when the oven reaches temperature.
<b>The oven is loud during PYROLYTIC CLEAN</b>	The cooling fan is operating at its highest speed.	This is normal. The fan will turn off when the oven has cooled.
<b>The PYROLYTIC CLEAN cycle has finished but the oven door will not open</b>	The oven is locked because it is still too hot to be used for cooking.	The oven will unlock once it has reached a safe temperature.

## MANUFACTURER'S WARRANTY

---

Please read this warranty card carefully. Attach your purchase receipt to this warranty card and keep in a safe place. You must produce both warranty card and proof of purchase in the event of a warranty repair being required.

When you purchase any new Haier Product you automatically receive a two year Manufacturer's Warranty covering parts and labour for servicing.

### The Manufacturer undertakes to:

Repair or, at its option, replace without cost to the owner either for material or labour any part of the Product, the serial number of which appears on the Product, which is found to be defective within TWO YEARS from the date of purchase.

### This warranty DOES NOT cover:

- (A) Service calls which are not related to any defect in the Product. The cost of a service call will be charged if the problem is not found to be a Product related fault. For example:
  - ① Correct the installation of the product.
  - ② Provide Instruction on use of the product or change the setup of the product.
  - ③ Replace house fuses or correct house wiring.
  - ④ Correcting faults) caused by the user.
  - ⑤ Noise or vibration that is considered normal.
  - ⑥ Water on the floor due to incorrect loading or excessive suds.
  - ⑦ Blocked pumps, removal of foreign objects/substances from the machine, including the pump and inlet house filters.
  - ⑧ Correcting damage caused by pests, eg. rats, cockroaches etc.
  - ⑨ Correct corrosion or discolouration due to chemical attack.
  - !0 Power outages or surges.
- (B) Defects caused by factors other than:
  - ① Normal domestic use or
  - ② Use in accordance with the Product's User Guide.
- (C) Defects to the Product caused by accident, neglect, misuse or 'Act of God'.
- (D) The cost of repairs carried out by non-authorized repairers or the cost of correcting such unauthorised repairs.
- (E) Normal recommended maintenance as set out in the Product's User Guide.
- (F) Repairs when the appliance has been dismantled, repaired or serviced by other than an AUTHORISED CUSTOMER SERVICE CENTRE or the selling dealer.
- (G) Pick up and delivery.
- (H) Transportation or travelling costs involved in the repair when the product is installed outside the AUTHORISED CUSTOMER SERVICE CENTRE'S normal service area.

This product has been designed for use in a normal domestic environment. It is not intended for commercial use. Doing so may affect product warranty.

Service under this warranty must be provided by an Authorised Service Repairer (refer to the Customer Care section for contact details). Such service shall be provided during normal business hours. This warranty certificate should be shown when making any claim.

## MANUFACTURER'S WARRANTY

---

**Note:**

This Warranty is an extra benefit and does not affect your legal rights and applies only to product purchased in New Zealand and Australia. Please keep this Warranty Card in a safe place.

**For Australian customers:**

Our goods come with guarantees that cannot be excluded under the Australian Consumer Law. You are entitled to a replacement or refund for a major failure and for compensation for any other reasonably foreseeable loss or damage. You are also entitled to have the goods repaired or replaced if the goods fail to be of acceptable quality and the failure does not amount to a major failure.

## CUSTOMER SERVICE

---

We recommend our Haier Customer Service and the use of original spare parts.

If you have a problem with your appliance, please first check TROUBLESHOOTING. If you cannot find a solution there, please contact:

- Your local dealer
- The Service & Support area at **www.haier.com.au** or **www.haier.co.nz**

where you can activate the service claim and also find FAQs.

To contact our Service, ensure that you have the following data available.  
The information can be found on the rating plate at the door.

Model \_\_\_\_\_

Serial No. \_\_\_\_\_

### Complete and keep for safe reference:

Model \_\_\_\_\_

Serial No. \_\_\_\_\_

Purchase Date \_\_\_\_\_

Purchaser \_\_\_\_\_

Dealer \_\_\_\_\_

Suburb \_\_\_\_\_

Town \_\_\_\_\_

Country \_\_\_\_\_



# Haier

---

[WWW.HAIER.COM.AU](http://WWW.HAIER.COM.AU)  
[WWW.HAIER.CO.NZ](http://WWW.HAIER.CO.NZ)