

FISHER & PAYKEL

**FREESTANDING QUAD DOOR
REFRIGERATOR FREEZER**

CONTEMPORARY

RF730QZUVB1, RF730QNUVX1 & RF730QNUVB1 models

USER/INSTALLATION GUIDE

NZ AU

CONTENTS

Safety and warnings	5
Before you begin	9
Using the control panel	10
Using your appliance	11
Wi-Fi connection	22
Care and cleaning	23
Foodcare	33
Moving or storing your appliance	34
ActiveSmart™ sounds	35
Troubleshooting	36
Manufacturer's Warranty and Service guide	41
Installation guide	

Registration

To register your product visit our website: fisherpaykel.com/register

SAFETY AND WARNINGS

⚠ WARNING!



Electric Shock Hazard

Failure to follow this advise may result in death, electric shock, fire or injury to persons.

- Read and follow the safety and warnings outlined in this user guide before operating this appliance.

⚠ WARNING!



Risk of fire/flammable material

This refrigerator contains flammable refrigerant isobutane (R600a).

READ AND SAVE THIS GUIDE

Use this appliance only for the intended purpose as described in this user guide.

When using this appliance always exercise basic safety precautions including the following:

General

- This product has been designed for use in a normal domestic (residential) environment.
- This appliance can be used by children aged 8 years and above and persons with reduced physical, sensory or mental capabilities or lack of experience and knowledge if they have been given supervision or instruction concerning use of the appliance in a safe way and understand the hazards involved.
- Children aged 3 to 8 years may load and unload this appliance under supervision.
- Children should be supervised to ensure that they do not play with the appliance.
- Cleaning and user maintenance shall not be made by children without supervision.
- Do not use mechanical devices or other means to accelerate the defrosting process, other than those recommended by the manufacturer.
- Do not damage the refrigerant circuit.
- In case of damage to the refrigerant circuit, ventilate the area by opening all windows. Do not operate electrical equipment or any other equipment that may produce arcs, sparks or flames in the area. Contact your Fisher & Paykel trained and supported service technician immediately to arrange for the appliance to be repaired.
- It is hazardous for anyone other than an Authorised Service Person to service this appliance. In Queensland – the authorized Service Person MUST hold a Gas Work Authorisation for hydrocarbon refrigerants, to carry out Servicing or repairs which involve the removal of covers
- Opening the door for long periods can cause a significant increase of the temperature in the compartments of the appliance.
- This refrigerating appliance is intended to be used at ambient temperatures ranging from 16°C to 43°C. The product performance may be compromised when operating outside of this temperature range.

Electrical

SAFETY AND WARNINGS

- This appliance must be installed in accordance with the installation instructions before use.
- To allow disconnection of the appliance from the supply after installation, incorporate a switch in the fixed wiring in accordance with the wiring rules.
- Never unplug your refrigerator by pulling on the power cord. Always grip the plug firmly and pull straight out from the outlet.
- Do not plug in any other appliance at the same power point as your refrigerator or use extension cords or double adapters.
- Repair or replace immediately all electric service cords that have become frayed or otherwise damaged. Do not use a cord that shows cracks or abrasion along its length or at either the plug or appliance end.
- If the power supply cord is damaged, it must only be replaced by your Fisher & Paykel trained and supported service technician because special purpose tools are required.
- When moving your appliance away from the wall, be careful not to roll over or damage the power cord.
- Do not use electrical appliances inside the food storage compartments of the appliance, unless they are of the type recommended by the manufacturer.
- When positioning the appliance, ensure the power cord is not trapped or damaged.
- Do not locate multiple portable socket-outlets or portable power supplies at the rear of the appliance.

Servicing

- The LED light cannot be serviced by the user. Contact your Fisher & Paykel trained and supported service technician.
- Your refrigerator is designed to operate for many years without the need for service checks. However, if your refrigerator is malfunctioning, have it attended to by your Fisher & Paykel trained and supported service technician as soon as possible. All electrical repairs must be carried out by an adequately trained service technician or qualified electrician.
- It is hazardous for anyone other than a Fisher & Paykel trained and supported service technician to service this appliance.

Cleaning

- Many commercially available cleaning products contain solvents that may attack the plastic components of your refrigerator and cause them to crack.
- Avoid using anti-bacterial cleaning products on either the interior or exterior of the cabinet as they may cause rusting of metal components and cracking of plastic components.
- Please refer to the 'Care and cleaning' section of this user guide for further information.

Disposal

- Extreme care must be taken when disposing of your old appliance to avoid hazards:
 - The flammable refrigerant gas must be safely removed.
 - The thermal insulation foam in this appliance contains flammable insulation blowing gases, any exposed foam may be highly flammable and must be carefully treated during disposal.
 - The doors and panels should be removed and the shelves left in place so that children may not easily climb inside.
- Your Fisher & Paykel trained and supported service technician will be able to give advice on environmentally friendly methods of disposing of your old refrigerator or freezer.

Food Safety

SAFETY AND WARNINGS

- Regularly clean surfaces that come into contact with food.
- Ensure any raw meat or fish is stored in sealed containers to prevent cross-contamination.
- Immediately clean any drips or spills on surfaces.
- If the appliance will be left empty for long periods, switch off, defrost, clean, dry, and leave the door open to prevent mould developing within the appliance.
- Opening the door for long periods can cause a significant increase of the temperature in the compartments of the appliance.

Storing food and drinks

- Do not store explosive substances such as aerosol cans with a flammable propellant in this appliance.
- Never store volatile or flammable materials in your refrigerator as they may explode.
- Never freeze liquids in glass containers. Liquid expands during freezing, which may cause the container to explode.
- Never freeze carbonated drinks. They may explode.
- Do not consume food if it is too cold. Food removed from the freezer compartment may be cold enough to cause damage when brought into contact with bare skin, eg frozen ice cubes.

Power failure — food safety

- Do not refreeze frozen foods that have thawed completely. The food may be dangerous to eat. Follow the recommendations below if you discover food in your freezer has thawed:
 - Ice crystals still visible — food may be refrozen but should be stored for a shorter period than recommended.
 - Thawed but refrigerator cold — refreezing generally not recommended. Fruits and some cooked food can be refrozen but use as soon as possible. Meat, fish, poultry — use immediately or cook then refreeze. Vegetables — discard as they usually go limp and soggy.
 - Thawed and warmer than 5°C — discard all food.

Water filter

- The water filter cartridge needs to be changed when the replacement indicator icon illuminates. This will happen every 6 months.
- If the water filtration system has been allowed to freeze, replace filter cartridge. Failure to replace the disposable filter at recommended intervals may lead to reduced filter performance and failure of the filter, causing property damage from water leakage or flooding.
- When installing the product use new tubing supplied with the refrigerator, DO NOT reuse any existing water connections.
- The water system is designed to operate between 138–827kPa (20–120psi). DO NOT install if water pressure exceeds 827kPa (120psi).
- In cases of excessively reduced filter life — we recommend that you consult a local plumber or your water supplier for advice on suitable filtration requirements for the water supplied to your home.
- Filter replacement is the consumer's responsibility and will not be covered by the warranty except in the case of faulty parts or materials within the filter cartridge.
- To reduce the risk associated with choking:
 - DO NOT allow children under 3 years of age to have access to small parts during the installation of the water filter.

SAFETY AND WARNINGS

- If using the automatic icemaker after an extended period of no use, or if the ice has developed an unpleasant taste or odour, dispose of ice in the storage container. If the problem persists, replace the water filter cartridge and refer to the flushing instructions detailed in the guide provided with your filter or your installation guide for your appliance.
- If the water tank has not been used for an extended period of time, or has developed an unpleasant taste or odour, flush the water system. If the problem persists, replace the water filter cartridge and refer to the flushing instructions detailed in the guide provided with your filter or your installation guide for your appliance.
- To avoid serious illness or death, only connect your water filter to safe drinking water.

Ice making

- Avoid contact with the moving parts of the ice maker ejector mechanism, and do not place your fingers on the automatic ice-making mechanism while the appliance is in operation.

BEFORE YOU BEGIN

- Ensure the installer has completed the final checklist in the installation guide.
- Read this guide, taking special note of the safety and warnings section.
- Remove all packaging and dispose of it responsibly. Recycle items that you can.

Fridge compartment

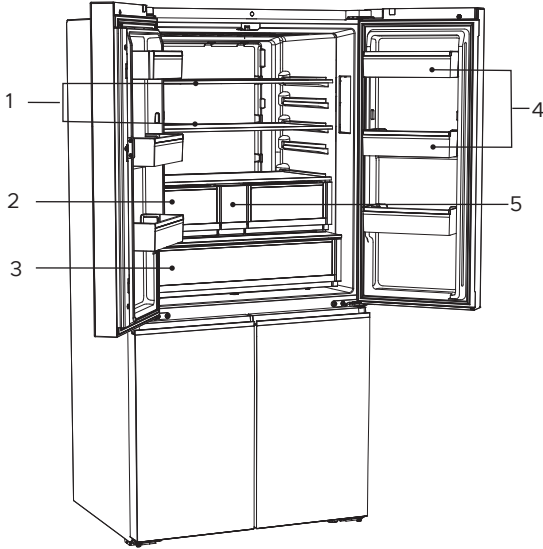

Refrigerator features

- ① Adjustable shelving
- ② Humidity control bins – small
- ③ Humidity control bin – large
- ④ Door shelves
- ⑤ Water filter

Freezer compartment

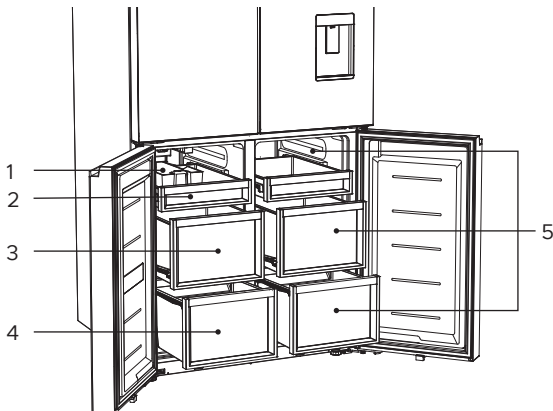



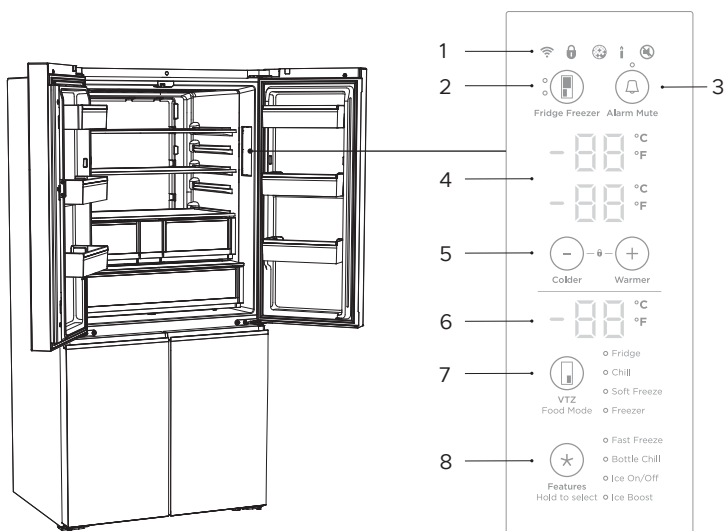

Freezer features

- ① Ice storage bin with scoop
- ② Tray
- ③ Mid bin
- ④ Bottom bin
- ⑤ Variable Temperature Zone

USING THE CONTROL PANEL



-
- 1  Illuminates when Wi-Fi is enabled.
-
-  Illuminates to indicate that the keys on the control panel are locked. When the door is closed the display is automatically locked.
-
-  Illuminates when the water filter needs replacing.
-
-  Illuminates to indicate that Sabbath mode is activated.
-
-  Illuminates to indicate key press sounds are deactivated.
-
- 2 Fridge/Freezer activates control panel when pressed. Allows you to select the fridge or freezer compartment to adjust the temperature.
- Upper light to indicate the fridge compartment is selected.
 - Lower light to indicate the freezer compartment is selected.
-
- 3 Alarm mute deactivates the door alarm for 20 minutes.
-
- 4 Displays the set temperature of the Fridge/Freezer compartments.
To change between Celsius and Fahrenheit on the display:
Press **+** for six seconds.
-
- 5 Allows you to adjust the temperature of the selected compartment.
-
- 6 Displays the set temperature of the Variable Temperature Zone (VTZ).
To change between Celsius and Fahrenheit on the display:
Press **+** for six seconds.
-
- 7 Allows you to select the food mode for the Variable Temperature Zone (VTZ) — FRIDGE, CHILL, SOFT FREEZE, FREEZER. Lights illuminate to indicate which food mode is selected.
-
- 8 Allows you to scroll and select features: FAST FREEZE, BOTTLE CHILL, ICE ON/OFF, ICE BOOST.
-

USING YOUR APPLIANCE

Temperature control

When you turn your refrigerator on for the first time, the cooling system will automatically cool all compartments to their set temperatures within 2–3 hours.

The internal control panel enables you to change and control the temperature of all compartments accurately and independently. The internal control panel default setting is to show the set temperature for the fridge compartment.

For common foodstuffs, the factory default setting provides the optimum setting for foodcare.

How to adjust the temperature – Fridge compartment

1

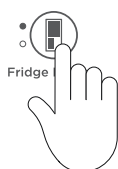

Press  once.

The fridge compartment light will illuminate.

2

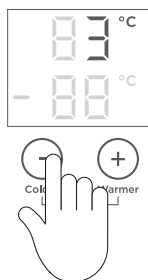

Press **+** to increase the temperature, press **-** to decrease the temperature.

USING YOUR APPLIANCE

How to adjust the temperature – Freezer compartment

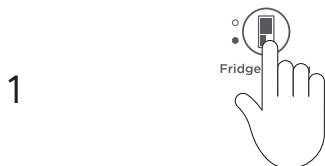

Press  twice to adjust the frozen food compartment temperature.
The freezer compartment light will illuminate.

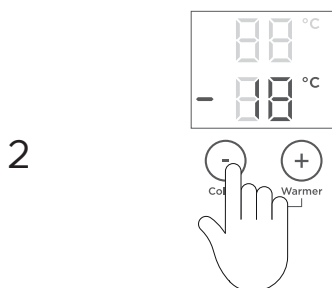



Press **+** to increase the temperature, press **-** to decrease the temperature.

Door alarms

If the fridge compartment door is left open, the alarm will beep after 90 seconds, if the freezer compartment door is left open the alarm will beep after 60 seconds. If either of the doors remains open, subsequent beeps will sound every 30 seconds for five minutes and the internal light(s) will turn off.

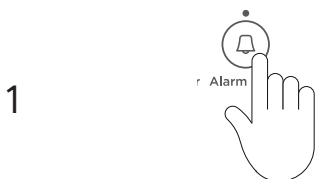
Alarm mute



To activate/deactivate ALARM MUTE, press  once. The light above the  button will illuminate to indicate the refrigerator is muted. ALARM MUTE will automatically deactivate after 20 minutes or when the door is closed. BOTTLE CHILL alarm is still operational.

Key mute

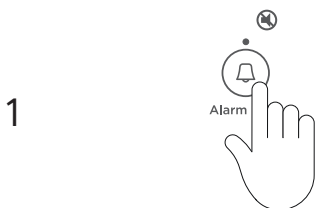

To activate/deactivate KEY MUTE, press  for four seconds.

Once KEY MUTE is activated the  icon on the internal control panel illuminates, all key sounds are silenced.

Door alarms and the BOTTLE CHILL alarm are still operational.

USING YOUR APPLIANCE

Key lock

KEY LOCK allows you to disable the buttons on the internal control panel. This is useful when cleaning your refrigerator.

1

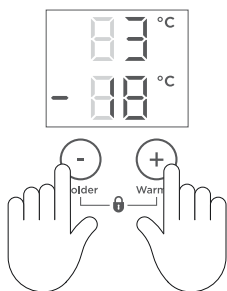

To activate/deactivate KEY LOCK, press **-** and **+** together for four seconds.

When KEY LOCK is activated the  icon on the internal control panel will illuminate. Pressing any of the buttons will sound several beeps to tell you that they are disabled.

Sabbath mode

In SABBATH MODE, alarms, lights and displays are deactivated for 80 hours.

Once in Sabbath mode:

- The interior light will not turn on when you open the refrigerator.
- The door alarms will not operate.
- The display will not illuminate, except the Sabbath mode icon.
- The internal and external control panels will not operate.
- Sabbath mode automatically deactivates after 80 hours.

1

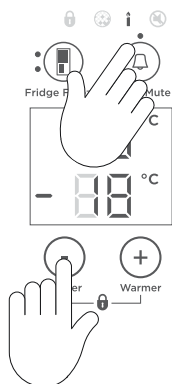





To activate/deactivate SABBATH MODE, press **Fridge F**, **Mute** and **-** together for four seconds. The  icon on the internal control panel will illuminate when SABBATH MODE is activated.

If you turn off your refrigerator while in SABBATH MODE it will resume automatically once the refrigerator is switched on again.

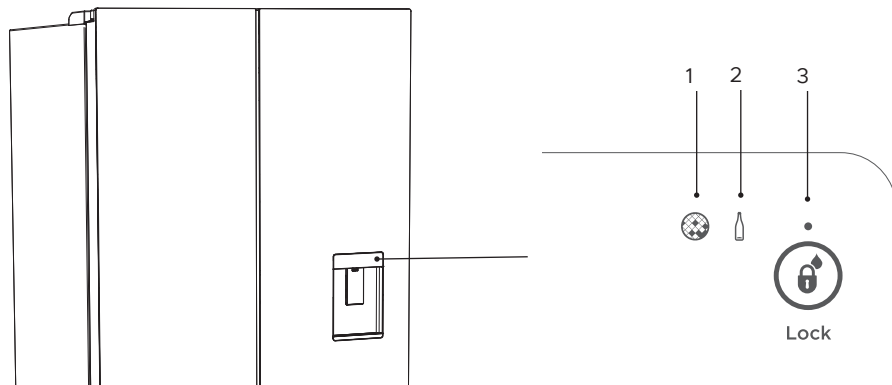
USING YOUR APPLIANCE

Water dispensing



- | | | | |
|---|--|---|---|
| 1 | Filter change indicator |  | Icon will illuminate when water filter requires changing. |
| 2 | Bottle Chill indicator |  | An alarm will sound and BOTTLE CHILL will flash after the elapsed time to remind you to remove your beverage. |
| 3 | Dispenser lock button and LED light |  | Locks/unlocks the water dispenser. The LED above the lock button will illuminate when dispenser is locked. |

Using your water dispenser

Ensure you have followed the steps outlined in your installation guide prior to your first use of the water dispenser.

Dispensing

Your water dispenser is designed for one-handed operation.

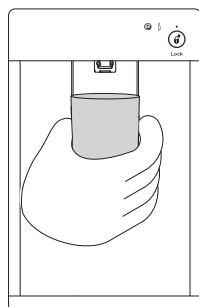

- ① To dispense water, gently press the dispensing pad with a glass or container.
- ② To stop the flow of water, simply pull your glass or container away from the dispensing pad.

Pressing hard against the dispensing pad will not increase the flow or dispense more water.

USING YOUR APPLIANCE

Dispenser lock

The DISPENSER LOCK is located on the external display and can be activated to prevent water from being dispensed. This is useful when you are cleaning the external display or when there are small children around.

1



To activate/deactivate DISPENSER LOCK, press  for four seconds.

When activated the light above the button will illuminate.

When the dispenser pad is pressed, several beeps will sound to alert the user that water cannot be dispensed.

Water filter



The water supplied to your refrigerator is filtered to remove impurities through a filter located internally between the vegetable bins in the refrigerator.

- There is a replacement indicator icon  on the internal control panel and external display which will appear when the filter needs replacing. The icon will flash, as a reminder, when water is dispensed.
- Replacement filter cartridges are available from your Fisher & Paykel dealer, online or from a Fisher & Paykel service technician. The details of the replacement filter cartridge are labelled on the cartridge.

Changing the water filter cartridge

Guidance of how to replace your water filter can be found at fisherpaykel.com/water-filter.

To reset the filter indicator:

- Press  and **+** together for 4 seconds.
- The  on the control panel will turn off when reset.

Do not reset indicator before filter is changed or filter monitoring will be inaccurate.

USING YOUR APPLIANCE

Information about your ice maker

Your automatic ice maker will produce eight cubes of ice every 2–3 hours, depending on the freezer compartment temperature and the number of door openings.

The ice tray will fill with water. When cubes are frozen, they will be ejected from the ice tray into the ice storage bin. Ice making will continue until the storage bin is full. Ice making will resume once you start to use the stored ice.

Your Ice & Water product comes with a smaller ice bin inside a tray. Attached to the ice storage bin is the scoop for the ice. This scoop provides hygienic access to the ice. For maximum ice storage, level the stored cubes with the ice scoop. Do not remove the ice bin when using the ice making function.

If ice is not used often, old cubes will become cloudy, taste stale, will shrink and may stick together. Empty the ice storage bin periodically and wash in lukewarm water. Dry thoroughly and place back into the correct position.

Turn your ice maker off if:

- There is no water supply for several hours.
- You are removing the ice storage bin for a period of time.
- You are going on holiday/vacation.

Glass shelves

There are two glass shelves that can be repositioned in the fridge compartment. For details on how to remove and replace glass shelving please refer to 'Cleaning and care – glass shelves'.

Humidity control lids

The humidity control lids are fitted to the bins in your fridge compartment.

These lids provide a humid microclimate to extend the storage times of fruit and vegetables.

The lids have specially designed grooves that retain moisture to prevent condensation from dripping onto the fruit and vegetables at times of high humidity.

USING YOUR APPLIANCE

Variable temperature zone

FOOD MODES

FREEZER (-18°C)	For general frozen food items that require storage between 1–12 months.	Meat, poultry, seafood, pre-cooked foods and leftovers, some fruits and vegetable, ice cream, and other frozen desserts.
SOFT FREEZE (-7°C)	Allows easy portioning of food and the ability to heat, cook or serve foods straight from the compartment without waiting for it to thaw.	Meats, seafood, soups, sauces, pureed foods, bread, desserts and pastries. Not recommended for storage of creamy desserts such as ice cream.
CHILL (0°C)	An extension of FRIDGE MODE providing the perfect storage zone for highly perishable food to ensure they retain their vital freshness and quality. These items will last slightly longer here compared with storage at FRIDGE MODE .	Highly perishable meats, poultry and seafood. Alcoholic beverages such as beer.
FRIDGE (3°C)	The ideal mode for fresh everyday foods such as fruit and vegetables, dairy products, meats and drinks.	Fruit and vegetables, dairy products, jams and chutneys/preserves, meats and drinks.

Changing the Food Mode

1



Press the **VTZ FOOD MODE**  button.

The digital display for the Fridge/Freezer compartment will not be illuminated.

The **FOOD MODE** scrolls from top to bottom (warmest setting to coldest setting).

The **FOOD MODE** selected will illuminate.

The **FOOD MODE** will be activated once the control panel is locked.

The Variable Temperature Zone display will automatically lock after 10 seconds or once the door is closed.

USING YOUR APPLIANCE

Adjusting the temperature

Each FOOD MODE will automatically default to the recommended temperature setting for that food mode, which is illuminated on the digital display. Once you have selected the required FOOD MODE the temperature can be adjusted as desired.

1

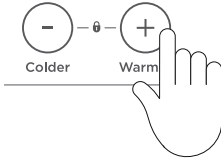

To increase the temperature of your selected FOOD MODE press **+**.

The digital display will change, at the warmest setting pressing the **+** button will sound the invalid button press melody. The digital display will not change.

2

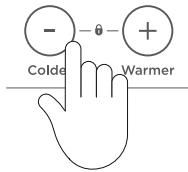

To decrease the temperature of your selected FOOD MODE press **-**.

The digital display will change, at the coldest setting pressing the **-** button will sound the invalid button press melody. The digital display will not change.

If you adjust the temperature for a FOOD MODE this adjustment will be remembered for the next time you use this FOOD MODE.

USING YOUR APPLIANCE

Features

Fast Freeze

FAST FREEZE boosts freezing speed by dropping the lower left freezer compartment to its coldest temperature for 12 hours, helping retain freshness, texture and taste during the freezing process.

1



To activate, press the ★ button to scroll through the features to FAST FREEZE.

The light next to the feature will flash.

To select the feature, press the ★ button for two seconds until flashing light turns solid.

2



To deactivate before the 12 hours has elapsed, press the ★ button and scroll to FAST FREEZE.

Press ★ button for two seconds.

For best results activate the function before it is required. Alternatively, activate it when placing food into the freezer.

Bottle Chill

BOTTLE CHILL rapidly chills your beverages in the freezer for a set time of 15 minutes. Depending on bottle size, you may need to return it to the freezer and reset.

1



To activate, press the ★ button, scroll to BOTTLE CHILL. The light next to the feature will flash.



Press the ★ button for two seconds until the flashing light turns solid.

An alarm will sound after 15 minutes to remind you to remove your beverage.

USING YOUR APPLIANCE

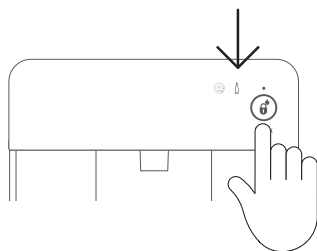

2



The  icon will flash on the external display. Press  on the external display to silence the alarm.

3



To deactivate before the time has elapsed, press the  button, scroll to BOTTLE CHILL. Press  button for two seconds.

When BOTTLE CHILL is deactivated the light will not illuminate.

Ice On/Off

ICE ON/OFF activates automatic ice – this is only available in the lower left compartment.

Your ice maker is designed to automatically dispense ice into the ice storage bin below until it detects the bin is full. The more ice you use, the more it makes. Before first use the automatic ice systems needs to be flushed.

1

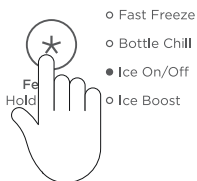

To activate, press the  button, scroll to ICE ON/OFF. The light next to the feature will flash.

Press the  button for two seconds until the light turns solid.

2



To deactivate, press the  button, scroll to ICE ON/OFF.

Press  button for two seconds.



When ICE ON/OFF is deactivated the light will not illuminate.

USING YOUR APPLIANCE

To flush the automatic icemaker

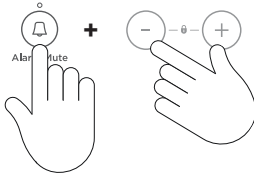
1



Press and hold  ,  and  together for four seconds.

The ice tray will flip twice and empty the water into the bin below. Repeat the cycle to help remove any dust in the ice tray collected during manufacture and transport.

Empty the water in the bin and return the bin correctly. Ensure that the scoop is located in front of the bin.

Once your ice maker is turned on, discard the first full bin of ice. This will flush away any impurities in the water line and ensure the best ice quality.

Carrying out the above steps after a holiday/vacation or extended periods of not using ice.

Ice Boost

ICE BOOST increases ice production by up to 30% and will automatically deactivate after 24 hours.

1



To activate, press the  button, scroll to ICE BOOST. The light next to the feature will flash.

Press the  button for two seconds until the light turns solid.

2

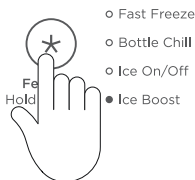

To deactivate, press the  button, scroll to ICE BOOST.

Press  button for two seconds.

When ICE BOOST is deactivated the light will not illuminate.

Deactivating ice making automatically deactivates the 'Ice Boost' function

WI-FI CONNECTION

Your appliance may be connected to your home wireless network and operated remotely using the app.

Getting started

- Ensure your home Wi-Fi network is turned on.
- You will be given step by step guidance on your mobile device.
- It may take up to 10 minutes to connect your appliance.

On your mobile device:

- ① Download the app from www.fisherpaykel.com/connect
- ② Register and create an account.
- ③ Add your appliance and set up the Wi-Fi connection.

Connecting to Wi-Fi

1

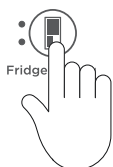

Press and hold  until both lights next to the button appear.

2



Press and hold  until  starts flashing.

Follow the prompts in the app to complete set-up.

CARE AND CLEANING

Exterior

Clean the full surface of the exterior door with liquid dishwashing detergent dissolved in warm water and a soft cloth. Wipe with a clean damp cloth to remove excess detergent. Dry the door with a lint-free cloth.

Clean off any oil or grease as soon as possible for ease of removal. Do not use any abrasive stainless steel cleaner, glass cleaners, solvents or scourer pads as these will damage the door surface. Do not write or draw on the doors.

Door gasket

Clean the magnetic door gasket every three months with a toothbrush, and liquid detergent dissolved in warm water.

Cabinet surround

To maximise operating efficiency regularly vacuum the flooring around your refrigerator. Cleaning behind your refrigerator is required once or twice a year.

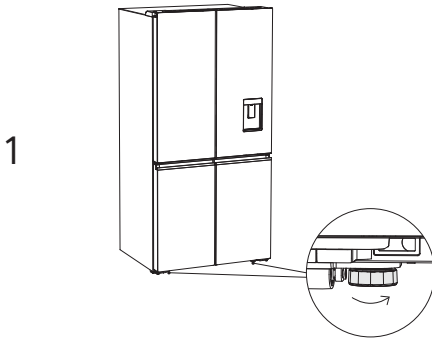

Wind up the feet and carefully ease the refrigerator out of its position.

Switch off and unplug.

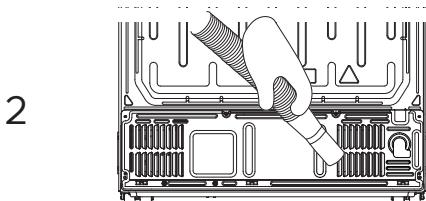

Vacuum the flooring behind your refrigerator and the rear compartment cover (where fitted) to remove dust.

Use a dry lint-free cloth to clean the refrigerator walls and surrounding cabinetry.

After cleaning, plug in and switch on.

Push the refrigerator into position and wind feet down.

CARE AND CLEANING

External display and water dispenser

1

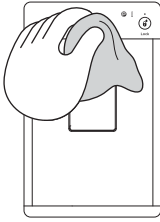

Activate the DISPENSER LOCK to prevent water from dispensing when cleaning. Press for four seconds.

Clean the pad and external display with a damp, soft lint-free cloth.

Drip tray

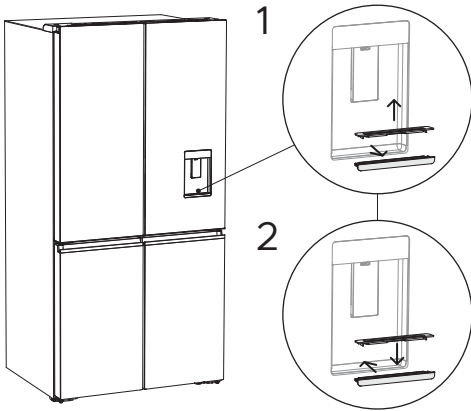

Remove the drip tray from the dispenser panel. Pull the two halves of the tray apart.

Clean with liquid detergent dissolved in water and a soft lint-free cloth.

Rinse with clean water and dry with a clean, lint-free cloth.

Securely clip the two halves together.

Re-insert the drip tray back into the dispenser panel, rounded sides first.

Interior

Do not use harsh chemicals, abrasives, ammonia, chlorine, bleach, concentrated detergents, solvents or abrasive scouring pads on any part of your refrigerator. Some of these chemicals may dissolve, damage and/or discolour the interior of your refrigerator.

Remove the shelves from the cabinet and door. Take care while removing shelves to prevent damaging the interior surfaces. Wipe all interior surfaces, using only liquid dishwashing detergent dissolved in warm water or baking soda dissolved in warm water (add 1tsp of baking soda to every 500ml of water) and a soft lint-free cloth. Rinse with clean water and dry with a clean, lint-free cloth.

Add a few drops of vanilla essence or vinegar to the water before cleaning to help remove “stale refrigerator” smell.

CARE AND CLEANING

Glass shelves – Refrigerator

To remove

1

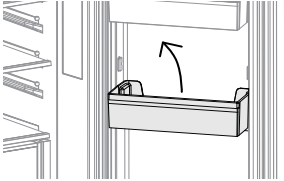

Remove all door shelves.

2

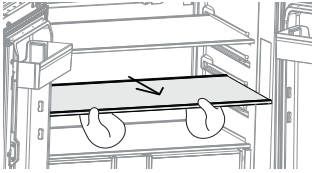

Lift the shelf slightly and pull towards you.

3

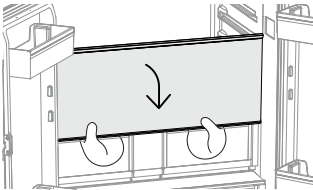

As you pull the shelf towards you, tilt the front downwards and lower until it is vertical.

4

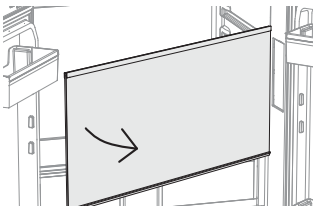

Remove the shelf from the compartment.

CARE AND CLEANING

Glass shelves – Refrigerator

To replace

1

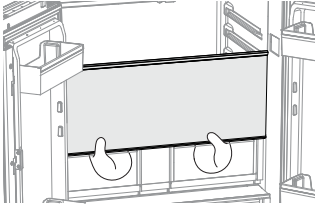

Holding the shelf vertical, manoeuvre the shelf back into the compartment.

2

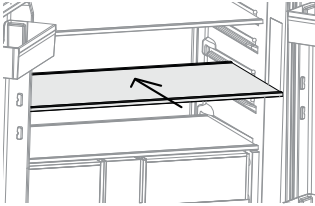

Tilt the shelf back into the compartment, guide the shelf onto the shelf supports and slide into the compartment.

3

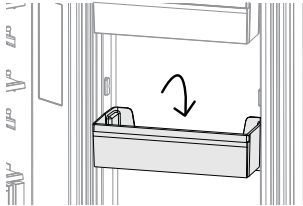

Re-install the door shelves.

CARE AND CLEANING

Humidity control bin – large

To remove

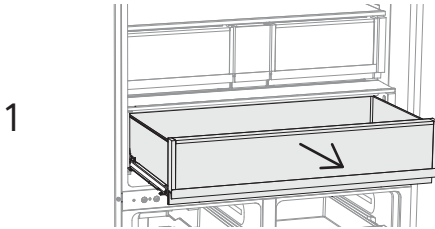

Remove food from the bin.
Pull the bin out to full extension.

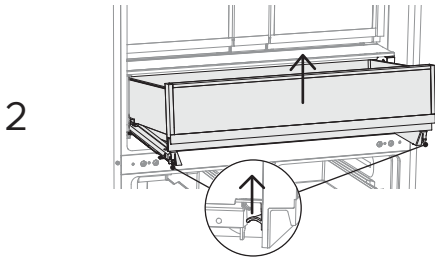

At the same time, on the left and right hand sides push the clip up and lift the bin to release.
Push the slides back into the compartment.

How to replace

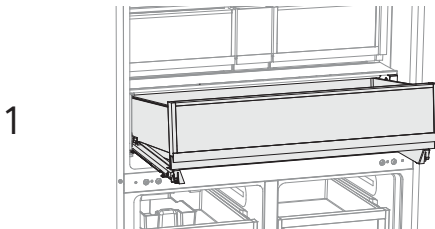

Extend the runners out from the refrigerator.
Place the bin on top of the runners.

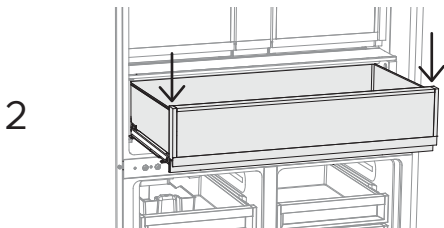

Gently push the bin down on both sides at the same time, until you feel it click into place.

CARE AND CLEANING

Humidity control bin – small

To remove

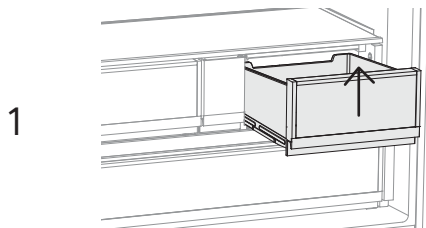

Remove food from the bin. Lift the bin up at the front and pull out over the ledge.

How to replace

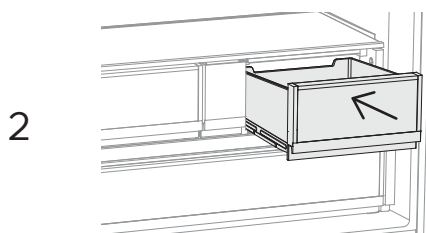

Line up the bin in position and push the bin back over the ledge.

Humidity control lid – small

To remove

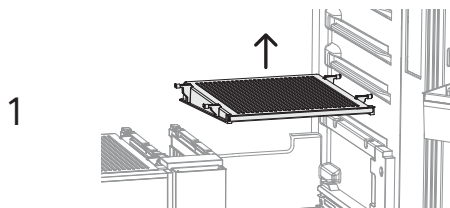

Remove the glass shelf sitting on top of the humidity control lid, follow the steps in section 'Glass shelving'.

Hold the humidity control lid and lift straight up.

CARE AND CLEANING

Humidity control lid large

To remove

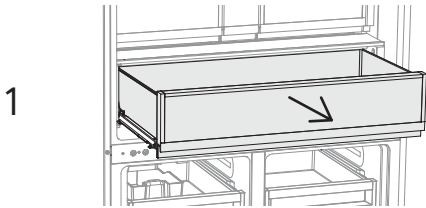

Remove the large humidity bin, refer to the section 'Humidity bin large'.

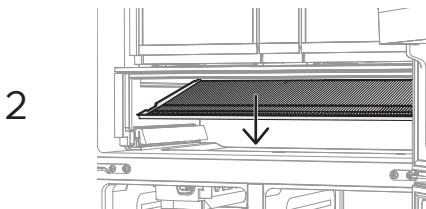

Locate the lip at the front of the humidity control lid and firmly pull down in the middle. Then pull the lid down at the back sides to dislodge.

Humidity control lid large

To replace

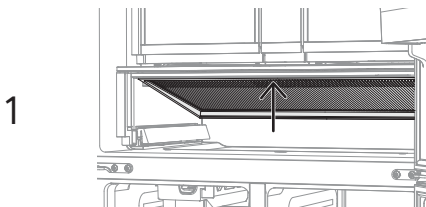

Put the humidity lid into the correct position. Slot the front of the humidity lid back into place.

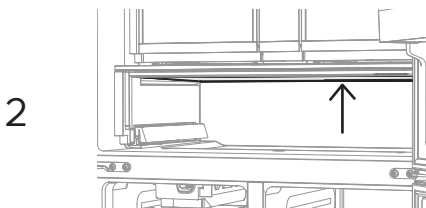

Once the front is in place, push the back and sides of the humidity lid into position.

CARE AND CLEANING

Freezer VTZ mid bin

To remove

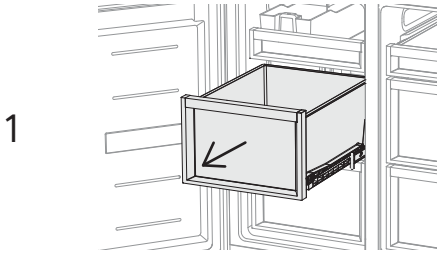

Remove food from the bin.
Pull the bin out to full extension.

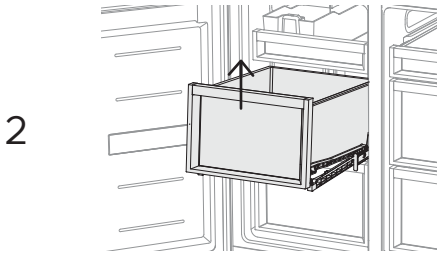

Lift up the bin to dislodge.
Push the slides back into the compartment.

How to replace

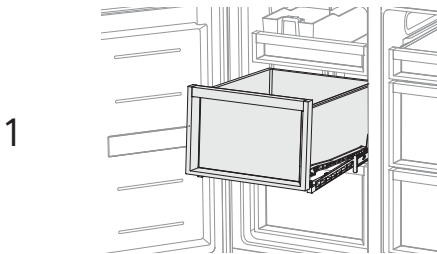

Extend the runners out from the refrigerator.
Place the bin on top of the runners.

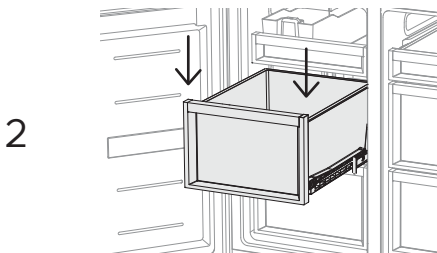

Gently push the bin down on both sides at the same time, until you feel it click into place.

CARE AND CLEANING

Freezer VTZ tray and large bottom bin

To remove

1

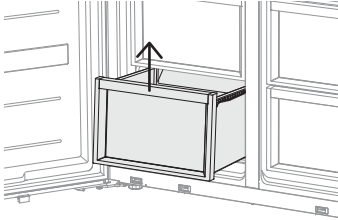

Remove food from the tray or bin. Lift the tray/bin up at the front and pull out over the ledge.

How to replace

1

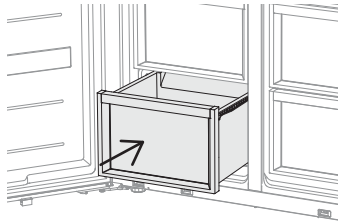

Line up the tray/bin in position and push the bin back over the ledge.

CARE AND CLEANING

Ice storage bin

To remove

1

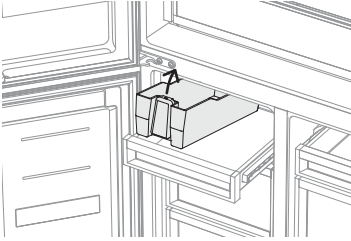

Pull out the tray. Tilt the front of the ice bin up to remove.

2

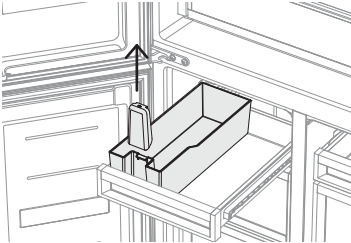

Ensure that the ice scoop is placed in the correct position, in the front of the bin.

Clean your ice bin and discard any old ice in the bottom of the bin regularly.

For best food care

- Store only high-quality, fresh food in your refrigerator.
- Store perishable foods in the refrigerator immediately after purchase. Storing at room temperature increases the rate of deterioration and can allow harmful microbial growth.
- Foods such as meat, poultry and seafood should be well wrapped or sealed in suitable packaging to prevent dehydration, colour deterioration, loss of flavour, and transfer of odour.
- We recommend storing these foods on the bottom shelf of your refrigerator or in one of the bins to prevent potential spills and cross-contamination with other foods.
- Ensure hot foods and beverages are cooled sufficiently before placing them into the refrigerator. Hot items may cause other foods to warm to unsafe temperatures. Hot items may also cause sealed items to sweat/condensate — which is undesirable.
- Beverages are best stored standing upright in the door shelves.
- Ensure raw and cooked foods are stored separately to avoid cross-contamination.
- Consume food items within the recommended storage times. Discard foods that show sign of spoilage.
- Keep door openings to a minimum to maintain optimum storage temperatures inside your refrigerator.
- We recommend using FAST FREEZE when you are adding food items to your appliance, such as after grocery shopping. This feature will ensure the food is frozen within the shortest period of time, locking in the freshness and extending the shelf life of your food.
- For storage of general household foods in the most efficient manner, it is recommended to use the product in the factory configuration supplied. Moving the shelves and bins will have a minimal impact on efficiency.
- Storing at temperatures other than settings recommended may impact the storage life.

Items stored in your refrigerator

- Eggs should be stored in their carton to avoid absorption of strong odours through their porous shell structure.
- Do not store chill sensitive items such as fruits and vegetables in a compartment when it is set to Chill mode. Cold temperatures may result in damage such as chill or freezing injury.

Items stored in your freezer

- We recommend cooling carbonated beverages only when the BOTTLE CHILL function is active.
- Do not store carbonated drinks without this function in the freezer. Failure to remove beverages could lead to freezing liquid and the likelihood of bottle/can explosion.
- Ensure air is removed from packaging to avoid large formation of ice crystals and prevent freezer burn.
- Defrosting food repeatedly is not recommended. Frozen foods that will be used regularly should be stored in smaller quantities.
- Do not store foods to be frozen in contact with food for storage. If defrosting frozen food in the refrigerator compartment ensure frozen items are not in contact with fresh foods.

MOVING OR STORING YOUR APPLIANCE

If your refrigerator is turned off for any reason, wait 10 minutes before turning it back on. This will allow the refrigeration system pressures to equalise before restarting.

Moving your refrigerator

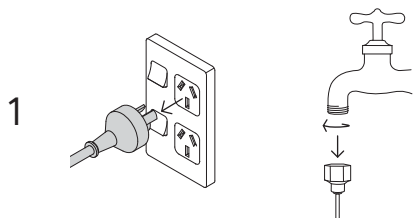

Turn off the power supply to the refrigerator. Unplug the power cord, turn off water supply at the isolation valve or mains supply depending on your installation. Disconnect the water hose.

Turn the adjustable feet to the right side as far as they will turn.

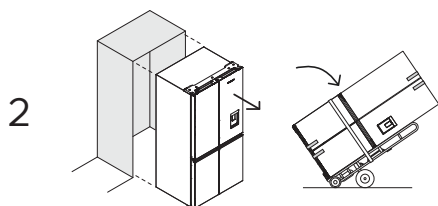

Ease the refrigerator out of its position. Tuck the power cord away, tape the shelves in place and tape the doors closed. If the cabinet needs to be placed at an angle or laid down, carefully lay it on its side (the right hand side when viewed from the front).

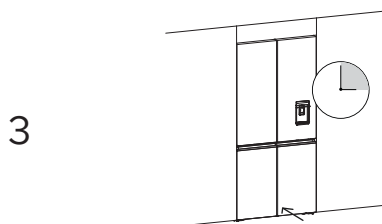

Relocate and install. If the refrigerator has been left on its side for any length of time, leave it standing upright as long as you can (a few hours) before turning on.

Normal refrigerator sounds

Your refrigerator is designed with innovative ActiveSmart™ features that can produce sounds that may be different from your old refrigerator.



Normal operational sounds include:

- Fan air flow sound. ActiveSmart™ refrigerators have fans which change speed depending on demand. During cooling periods, such as after frequent door openings, fans circulate the cold air in the fridge and freezer compartments producing some air flow sound. This is quite normal.
- Cracking or popping sound which may occur when the defrost function is operating.
- Running water sound. This is the liquid refrigerant in the system and can be heard as a boiling or gurgling noise.
- An audible hissing sound after closing the freezer door. This is due to the pressure difference between the warm air that has entered the cabinet and suddenly cooled, and the outside air pressure.
- Other sounds may be heard for the following reasons:
 - Cabinet not level.
 - Floor uneven or weak.
 - Bottles or jars rattling on shelves.
- If this is your first refrigerator with an ice maker, you will hear occasional sounds that may be unfamiliar. They are normal ice making sounds and are not cause for concern.
- The following sounds are normal with the operation of an ice maker:
 - Motor operation (low humming).
 - Running water as the ice maker and/or water tank fills.
 - Water valve opening and closing (hissing sound).
 - Ice being loosened from the ice moulding tray (cracking).
 - Ice dropping into bin (clunking).

TROUBLESHOOTING

If there is a problem with your refrigerator, please check the following points before contacting your local Fisher & Paykel trained and supported service technician or the Customer Care Centre.

Product parts and accessories can be purchased through Fisher & Paykel Customer Care Centre or online at fisherpaykel.com (this service is available to selected markets only).

PROBLEM	POSSIBLE CAUSES	WHAT TO DO
Refrigerator does not operate	No electricity at power outlet.	Check that the plug is correctly connected and power switched on.
		Check another refrigerator at the same outlet.
		Check house fuse.
Light not working	Light not functioning.	The LED light cannot be serviced by the user. Contact your Fisher & Paykel Dealer or Fisher & Paykel trained and supported service technician.
	Refrigerator not working.	Check refrigerator is turned on at wall.
Light and display not working	Product in SABBATH MODE.	Press and hold  ,  and  together for four seconds.
Motor operates for long periods	Hot weather.	Minimise door openings to allow temperature to stabilise.
	Frequent door openings.	
	Large amount of food recently added.	Refer to section 'Temperature control'.
	Temperature control set too low.	
	Doors not sealing properly.	Check that cabinet is level and gasket seals are clean.
Storage compartments too warm	Temperature setting not correct.	Refer to section 'Temperature control'.
	Frequent door openings.	Minimise door openings to allow temperature to stabilise.
	Large amount of food recently added.	
Food freezing in the refrigerator	Temperature setting not correct.	Refer to section 'Temperature control'.
	Food placed directly in front of air outlets.	Move chill sensitive foods away from the centre back of the shelves.

TROUBLESHOOTING

PROBLEM	POSSIBLE CAUSES	WHAT TO DO
Unfamiliar noises	Cabinet not stable or level. Freezer is defrosting.	Refer to your Installation guide or 'ActiveSmart™ sounds'.
Water in the vegetable bins	Condensation is formed by the water produced by fruit and vegetables.	A small amount of condensation is beneficial for fruit and vegetable storage. Wipe out water with a cloth.
Exterior of cabinet is warm	This is normal.	
Condensation on outside of refrigerator/freezer	Not unusual during periods of high humidity.	Wipe dry.
Condensation inside fridge compartment	Frequent or long door openings. Door gasket leaking.	Minimise door openings. Check that gasket is sitting flat and sealing tightly.
	Not unusual during periods of high humidity.	Wipe dry.
Door out of alignment	With time and usage, movement may occur.	Refer to your installation guide.
Tray/bin does not slide in and out evenly	Packaging trapped.	Check to ensure no food or packaging is trapped behind the tray/bin.
	Runners not extending fully.	Holding onto sides of tray/bin, extend the runners fully by using a firm pull – this will reset the runner.
Refrigerator operating inefficiently	Accumulation of dust on or behind the rear compartment cover.	Refer to section 'Care and cleaning'. If problem persists please contact Customer Care.
Cannot adjust temperature in frozen food compartment	Either BOTTLE CHILL, FAST FREEZE or ICE BOOST is activated.	Deactivate BOTTLE CHILL, FAST FREEZE or ICE BOOST if function is not desired.

TROUBLESHOOTING

PROBLEM	POSSIBLE CAUSES	WHAT TO DO
Automatic ice maker does not work	Ice maker has not been turned on.	Switch on ice maker.
	Bin is in the wrong way or there is no bin in place.	Place bin so scoop is in the front of the ice bin. Refer to section 'Care and cleaning'.
	Water supply turned off or not connected.	Ice bin sits directly under ice maker on top left side of freezer. Connect water supply.
	Freezer compartment not working.	Contact Customer Care.
	Water pressure too low.	Check water pressure.
	Water line kinked/squashed.	Check water line for kinks/squashing.
	Filter clogged.	Water filter may need replacing.
Ice cubes have odour/taste	Knob not in correct position.	Check knob is in lock position.
	Unsealed packages may be transmitting odour/taste.	Old cubes need to be discarded. Ensure food packaging is sealed.
	Interior of freezer needs cleaning.	Ice storage bin needs to be emptied and washed. Clean refrigerator.
	Poor taste from incoming water.	Filter may need to be replaced with new one. Force 2 – 3 ice tray flips.
Slow ice cube freezing	Door may have been left ajar.	Close door.
	Freezer compartment too warm.	Turn temperature to a colder setting.
Wet ice/ ice clumping	Low water pressure.	Check water pressure.
	Filter blocked.	Replace filter.
	Long freezer door openings.	Gently tap ice with scoop to unstick or, if large clumps occur, empty ice bin and make new ice.
	High ambient temperature.	
	Ice bin left out of freezer compartment for a length of time.	
Ice will stick together over time.		
Filter warning light  is flashing	Filter needs replacing.	Replace filter as soon as possible.

TROUBLESHOOTING

PROBLEM	POSSIBLE CAUSES	WHAT TO DO
Ice build up inside freezer compartment	Freezer door not closing tightly.	Arrange items in freezer so door can close tightly. Check and clean door gasket seal.
Ice maker makes unfamiliar sounds or seems too loud	Normal ice maker operation.	Refer to section 'ActiveSmart™ sounds'.
Ice boost function not increasing rate of ice production	Ambient temperature very warm. Refrigerator is in high usage.	Minimise door openings.

TROUBLESHOOTING

PROBLEM	POSSIBLE CAUSES	WHAT TO DO
Water has poor taste/odour	Refrigerator not used for an extended period.	Dispense 4L of water so fresh water supply is replenished.
	New filter installed.	
Water dispenser does not work	Water supply turned off or not connected.	Turn water on.
		Press dispenser for four minutes to remove trapped air from water line and to fill the water system.
	Supply line may be blocked.	Check supply for kinks or leaks.
	On first installation there may be air in water system.	To remove air, run 3L of water through the dispenser.
	Filter may be blocked and need replacing.	Replace filter (see your 'Service & Warranty' document provided with your refrigerator).
	DISPENSER LOCK activated.	Press and hold  for four seconds.
	Water frozen in tank.	Increase temperature to a warmer setting in fridge compartment and freezer.
Water in first glass is warm	Water dispenser not used for extended period.	Discard first glass of water dispensed.
	Tank capacity used recently.	Allow water time to cool.
Drips overflow drip-shelf	Air trapped in tank.	Flush 3L water through dispenser, stopping intermittently.
	New filter installed.	Dispense 4L of water through the dispenser, and then another 4L after four minutes.
Water flow rate has slowed down	Filter cartridge is restricted.	Replace filter as soon as possible.

MANUFACTURER'S WARRANTY AND SERVICE GUIDE

NZ



To access your Warranty and Service Guide

Scan the QR code with your smartphone to access your warranty and book a service, or view online at <https://www.fisherpaykel.com/nz/help-and-support/warranty-information>

AU



To access your Warranty and Service Guide

Scan the QR code with your smartphone to access your warranty and book a service, refer to your separate warranty and service book or view online at <https://www.fisherpaykel.com/au/help-and-support/warranty-information>

This product has been designed for use in a domestic (residential) environment. This product is not designed for any commercial use. Any commercial use by the customer will affect this products Manufacturer's Warranty.

Complete and keep for safe reference:

Model _____

Serial No. _____

Purchase Date _____

Purchaser _____

Dealer _____

Suburb _____

Town _____

Country _____

FISHER & PAYKEL

**FREESTANDING QUAD DOOR
REFRIGERATOR FREEZER**

CONTEMPORARY

RF730QZUVB1, RF730QNUVX1 & RF730QNUVB1 models

INSTALLATION GUIDE

NZ AU

CONTENTS

Safety and warnings	4
ActiveSmart™ Refrigerator	7
Unpacking and moving your appliance	8
Before installation	9
Supplied parts	10
Product dimensions	11
Cabinetry dimensions – Proud	13
Cabinetry dimensions – Flush	15
Electrical	17
Water connection	18
Flushing the water filter	20
Positioning your refrigerator	21
Complete installation	23
Final checklist	24

Registration

To register your product visit our website: fisherpaykel.com/register

SAFETY AND WARNINGS

⚠ WARNING!



Electric Shock Hazard

Failure to follow this advise may result in death, electric shock, fire or injury to persons.

- Read and follow the safety and warnings outlined in this guide before operating this appliance.

⚠ WARNING!



Risk of fire/flammable material

This refrigerator contains flammable refrigerant isobutane (R600a).

READ AND SAVE THIS GUIDE

Use this appliance only for the intended purpose as described in the user guide.

When using this appliance always exercise basic safety precautions including the following:

- Keep ventilation openings, in the appliance enclosure or the built-in structure, clear of obstruction.
- Do not damage the refrigerant circuit.
- In case of damage to the refrigerant circuit, ventilate the area by opening all windows. Do not operate electrical equipment or any other equipment that may produce arcs, sparks or flames in the area. Contact your Fisher & Paykel trained and supported service technician immediately to arrange for the appliance to be repaired.
- It is hazardous for anyone other than a Fisher & Paykel trained and supported service technician to service this appliance.
- In Queensland the authorised service person must hold a gas work licence or authorisation for hydrocarbon refrigerants to carry out service or repairs which involve removal of covers.
- Your refrigerator is designed to operate for many years without the need for service checks. However, if your refrigerator is malfunctioning, have it attended to by your Fisher & Paykel trained and supported service technician as soon as possible. All electrical repairs must be carried out by an adequately trained service technician or qualified electrician.
- This refrigerating appliance is not intended to be used as a built-in appliance.
- It is hazardous for anyone other than a Fisher & Paykel trained and supported service technician to service this appliance.
- This refrigerating appliance performs optimally at ambient temperatures ranging from 16°C to 38°C.

SAFETY AND WARNINGS

Electrical

- This appliance must be installed in accordance with the installation instructions before use.
- To allow disconnection of the appliance from the supply after installation, incorporate a switch in the fixed wiring in accordance with the wiring rules.
- Never unplug your refrigerator by pulling on the power cord. Always grip the plug firmly and pull straight out from the outlet.
- Do not plug in any other appliance at the same power point as your refrigerator or use extension cords or double adapters.
- Repair or replace immediately all electric service cords that have become frayed or otherwise damaged. Do not use a cord that shows cracks or abrasion along its length or at either the plug or appliance end.
- If the power supply cord is damaged, it must only be replaced by your Fisher & Paykel trained and supported service technician because special purpose tools are required.
- When moving your appliance away from the wall, be careful not to roll over or damage the power cord.
- Do not use electrical appliances inside the food storage compartments of the appliance, unless they are of the type recommended by the manufacturer.
- When positioning the appliance, ensure the power cord is not trapped or damaged.
- Do not locate multiple portable socket-outlets or portable power supplies at the rear of the appliance.

Water filter

SAFETY AND WARNINGS

- To reduce the risk associated with choking:
 - DO NOT allow children under 3 years of age to have access to small parts during the installation of the water filter.
- The water connection to your Ice & water refrigerator must be installed by a qualified plumber or Fisher & Paykel trained and supported service technician and comply with all state and local laws.
- Installation and use MUST comply with all state and local plumbing codes. Check with your local public works department for plumbing codes. You must follow their guidelines as you install the water filtration system.
- To avoid serious illness or death, only connect your water filter to safe drinking water.
- The water filter cartridge needs to be changed when the replacement indicator icon illuminates. This will happen every 6 months.
- If the water filtration system has been allowed to freeze, replace filter cartridge. Failure to replace the disposable filter at recommended intervals may lead to reduced filter performance and failure of the filter, causing property damage from water leakage or flooding.
- When installing the product use new tubing supplied with the refrigerator, DO NOT reuse any existing water connections.
- The water system is designed to operate between 138–827kPa (20–120psi). DO NOT install if water pressure exceeds 827kPa (120psi).
- To reduce the risk associated with property damage due to water leakage or flooding:
 - DO NOT install systems in areas where ambient temperatures may go above 38°C or drop below 0.6°C.
 - DO NOT install on hot water supply lines. The water filter system is designed with a maximum inlet temperature of 38°C.
 - DO NOT install where water hammer conditions may occur. If water hammer conditions exist, you must install a water hammer arrester.
- **To avoid serious illness or death, only connect your water filter to safe drinking water.**

ACTIVESMART™ REFRIGERATOR

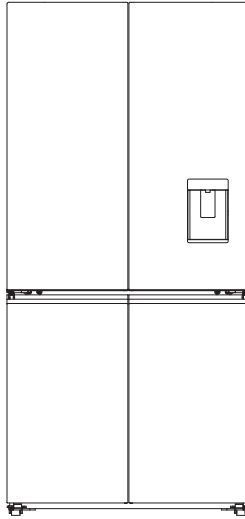

Quad Door Fridge Freezer, 905mm, 690L, Ice & Water
Contemporary
RF730QZUVB1, RF730QNUVX1 & RF730QNUVB1 models

UNPACKING AND MOVING YOUR APPLIANCE

Check that your appliance is the correct model as per your order.

Follow the steps below to move your appliance to the install location. Be careful when tilting the appliance forward/backward. Tape the door shut to prevent opening while moving the appliance.

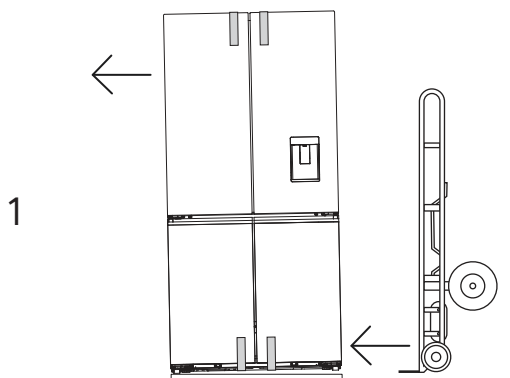

Tilt the appliance slightly forward and insert the hand truck between the plastic base and appliance (at the right hand side when viewed from the front).

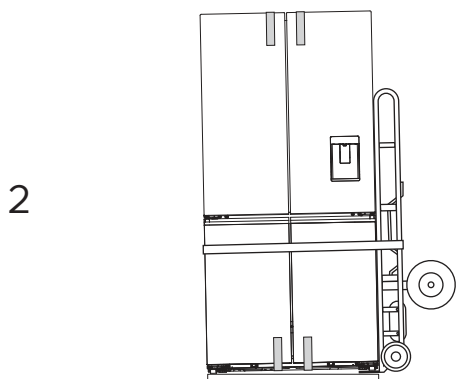

Restrain the appliance with a strap.

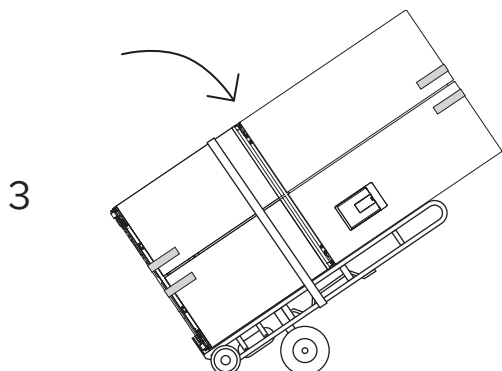

Tilt backward to load appliance onto hand truck and push to install location.

BEFORE INSTALLATION

Please follow the installation steps below to ensure your appliance operates correctly.

Before installation

Power

- Install your appliance where the plug is easily accessible.
- Connect your refrigerator to a separate power point. Avoid sharing the power point with other appliances. Do not use extension cords and double adaptors as the combined weight of two power cords can pull the double adaptor from the power outlet.
- For power requirements, refer to the information on the serial plate located at the front bottom right-hand side of the refrigerator when the door is open.
- Ensure your appliance is properly grounded (earthed).
- Connect the appliance to the electrical supply (220V – 240V 50Hz) with the fitted plug and lead.
- Connections to the mains supply should be in accordance with local regulations.

Ice & Water models

- Your Ice & Water refrigerator must be installed by a qualified plumber or Fisher & Paykel trained and supported service technician as incorrect plumbing can lead to water leaks.
- Fisher & Paykel Appliances does not accept responsibility for damage (including water damage) caused by faulty installation or plumbing.

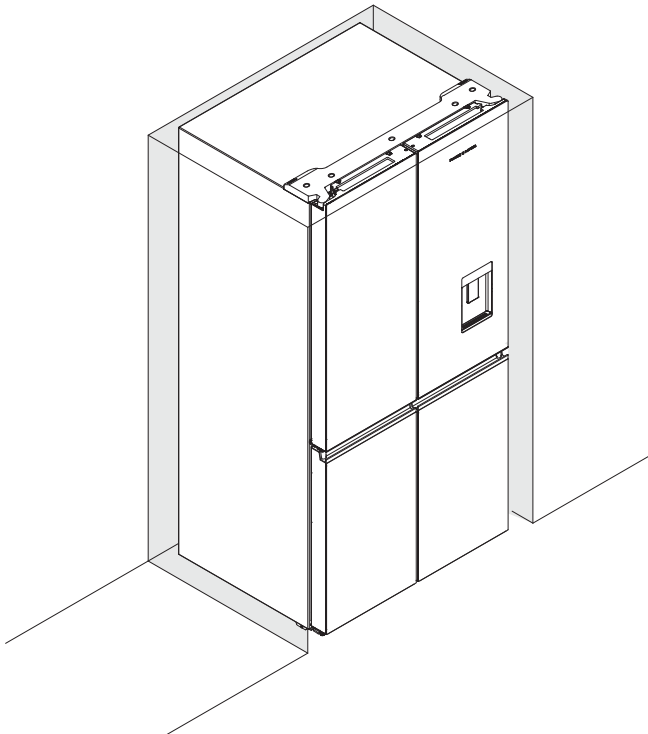

SUPPLIED PARTS

MISCELLANEOUS ITEMS PACK



User/Installation guide (1)

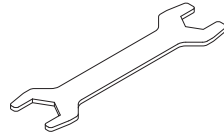

Spanner (1)

WATER FILTER KIT



Hose connector (2)

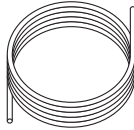

Water hose 4m (1)

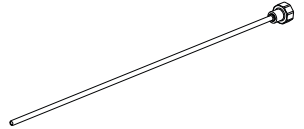

Tap adaptor brass 1/4 OD
1/2 BSP (1)

PRODUCT DIMENSIONS

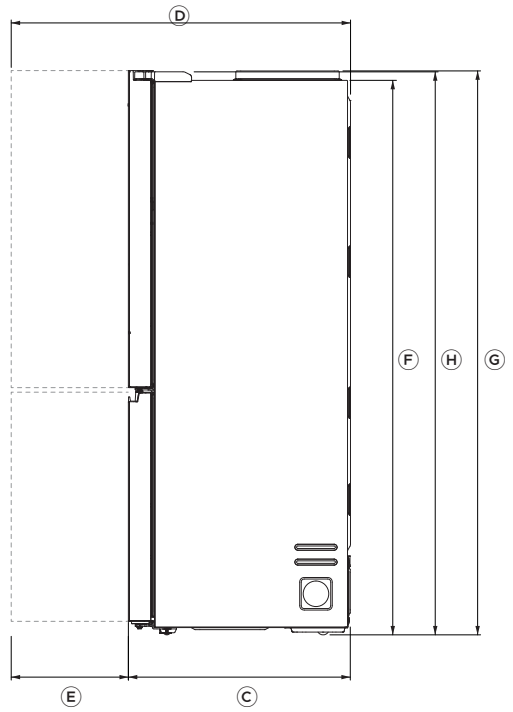
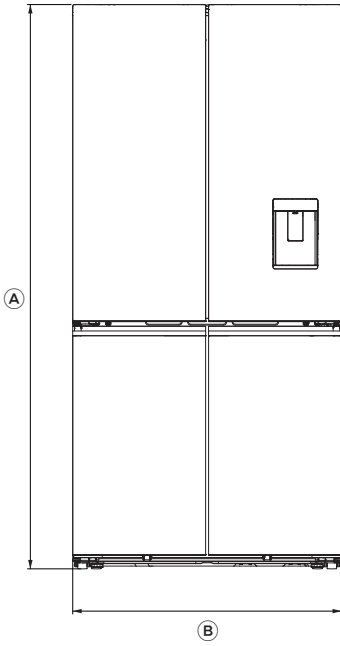
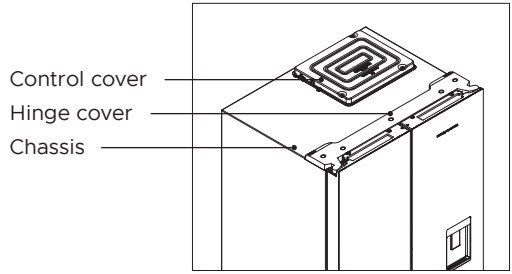
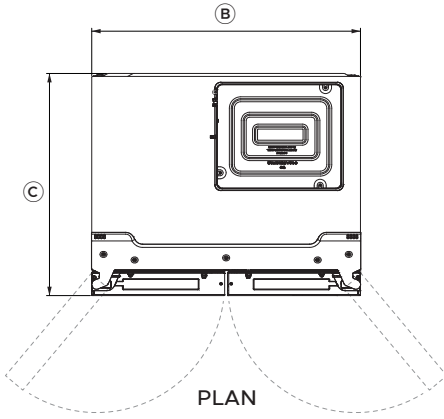

FRONT

PROFILE

PRODUCT DIMENSIONS

PRODUCT DIMENSIONS	MM
Ⓐ Overall height of product	1900
Ⓑ Overall width of product	905
Ⓒ Overall depth of product (excludes handle)	748
Ⓓ Depth with door open – from rear of fridge – 90° rotation	1142
Ⓔ Depth with door open – from flush with door – 90° rotation	394
Ⓕ Height to top of chassis	1867
Ⓖ Height to top of hinge cover	1896
Ⓗ Height to top of control cover	1899

Actual product dimensions may vary by ± 2mm

CABINETRY DIMENSIONS – PROUD

CUTOUT

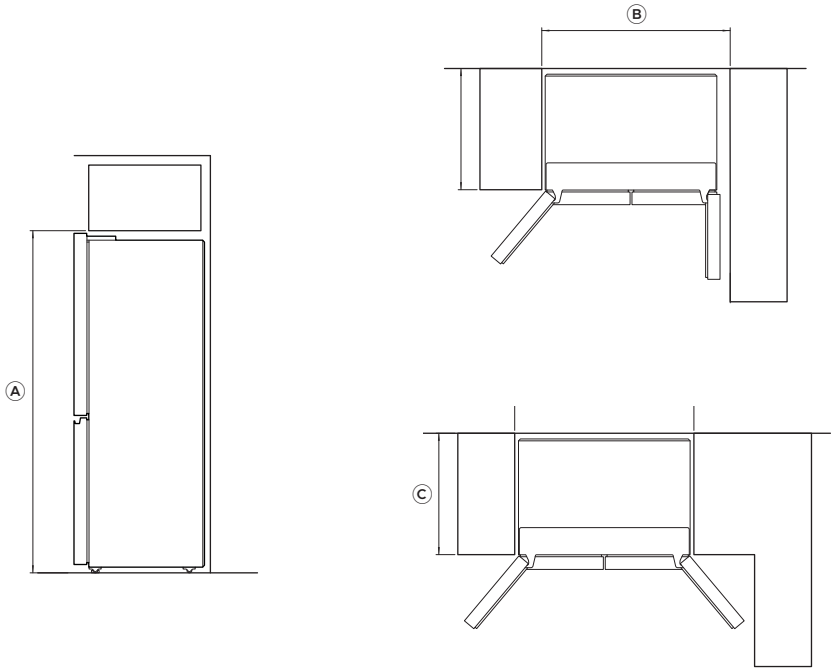

CABINETRY DIMENSIONS (incl. minimum air clearances)	RF730Q
	MM
Ⓐ Inside height of cavity*	1920
Ⓑ Inside width	
• 90° rotation**	985
• full rotation	945
Ⓒ Overall depth	690

*Measurement includes a feet increase of 10mm.

**For full drawer/shelf access, the doors need to be open past 90°. To avoid damaging the product ensure doors do not contact the adjacent cabinetry/wall.

CABINERY DIMENSIONS – PROUD

CLEARANCES

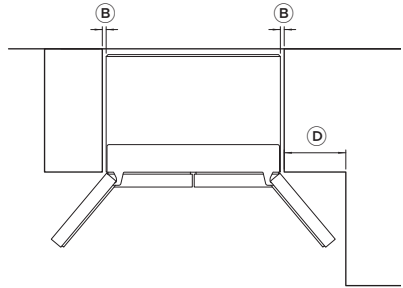
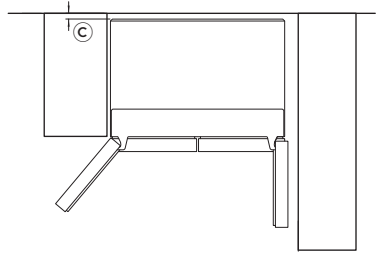
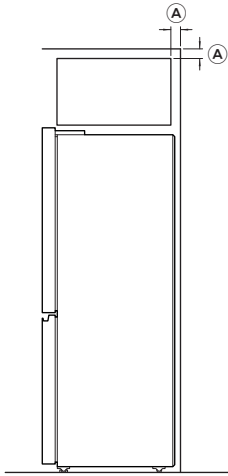

MINIMUM CLEARANCE DIMENSIONS

RF730Q

MM

Ⓐ Vent (above refrigerator cabinet or around top of cupboard)	50
Ⓑ Side clearance	
• 90° rotation*	60
• full rotation	20
Ⓒ Rear clearance	30
Ⓓ Door clearance	
• 90° rotation*	N/A
• full rotation	350

*For full drawer/shelf access, the doors need to be open past 90°. To avoid damaging the product ensure doors do not contact the adjacent cabinetry/wall.

CABINETY DIMENSIONS – FLUSH

CUTOUT

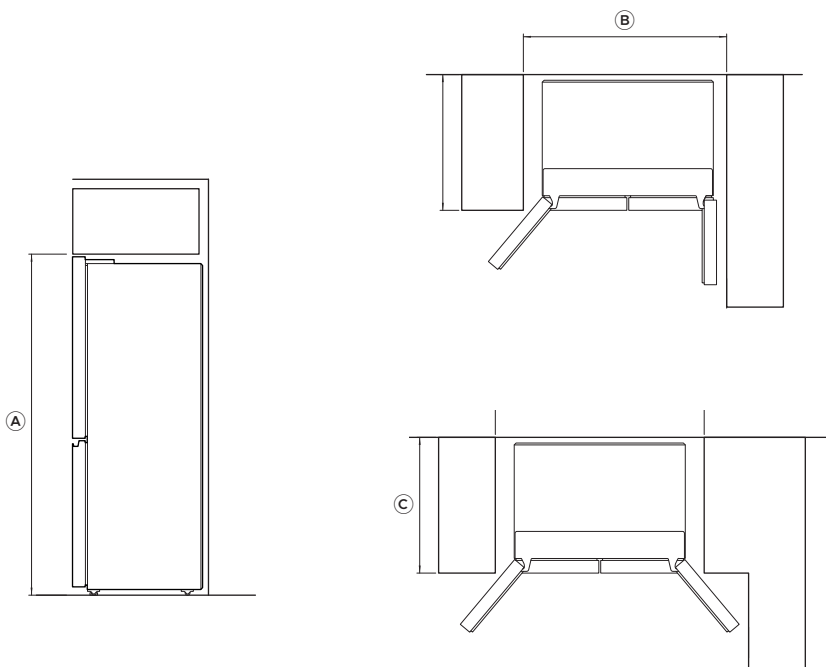

CABINETY DIMENSIONS (incl. minimum air clearances)	RF730Q
	MM
Ⓐ Inside height of cavity*	1945
Ⓑ Inside width	
• 90° rotation**	1075
• full rotation	1125
Ⓒ Inside depth	778

*Measurement includes a feet increase of 10mm.

**For full drawer/shelf access, the doors need to be open past 90°. To avoid damaging the product ensure doors do not contact the adjacent cabinetry/wall.

CABINERY DIMENSIONS – FLUSH

CLEARANCES

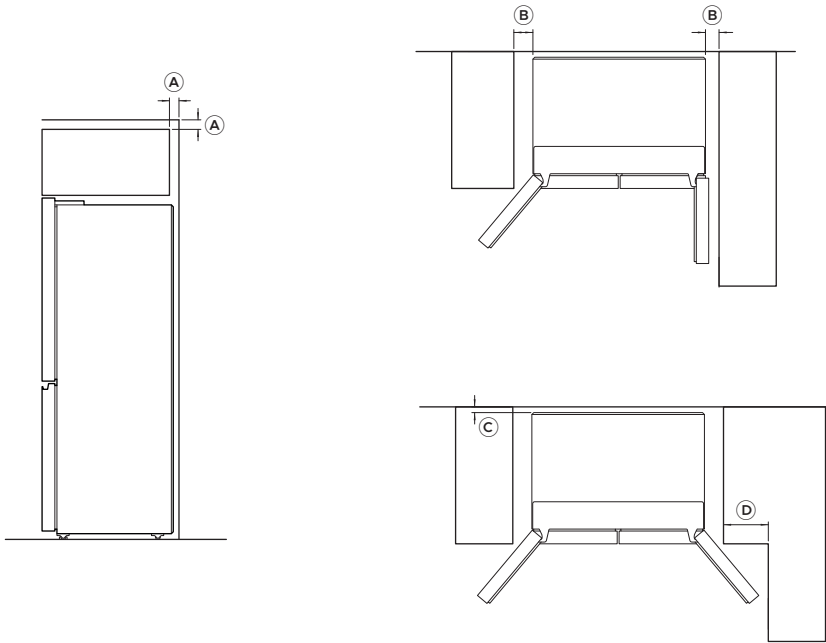

MINIMUM CLEARANCE DIMENSIONS

RF730Q

MM

Ⓐ Vent (above refrigerator cabinet or around top of cupboard)	50
Ⓑ Side clearance	
• 90° rotation*	60
• full rotation	110
Ⓒ Rear clearance	30
Ⓓ Door clearance	
• 90° rotation*	N/A
• full rotation	260

*For full drawer/shelf access, the doors need to be open past 90°. To avoid damaging the product ensure doors do not contact the adjacent cabinetry/wall.

ELECTRICAL

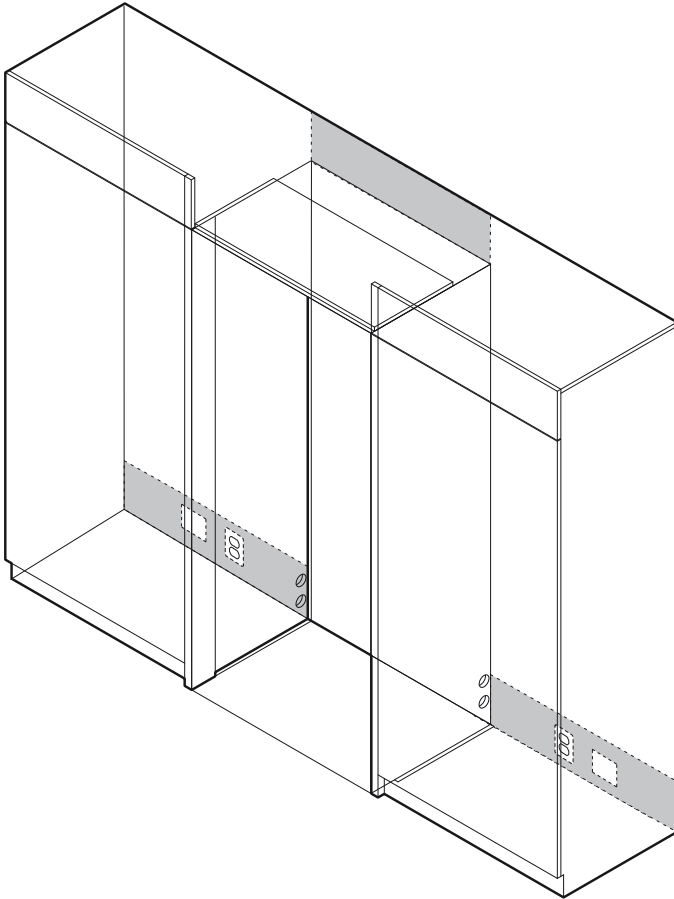

Electrical connection should be located in an adjacent cabinet to either side of the refrigerator or above the refrigerator cavity. We recommend the use of an isolating switch that is easily accessible to the user after the refrigerator is installed.

WATER CONNECTION

1

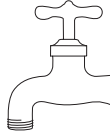
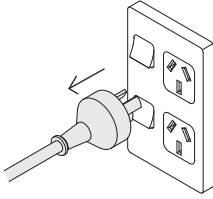

Ensure the refrigerator is not plugged into a power supply. Locate the isolation tap for cold water connection (tee and tap fitting not supplied).

2

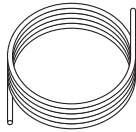

Locate the water filter kit to complete the water connection installation.

3

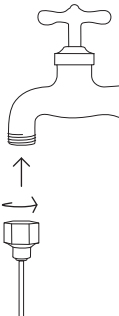

Fasten the tap adaptor with short tube to the isolation tap. Tighten by hand and tighten one additional turn with a spanner. Take care not to overtighten.

4

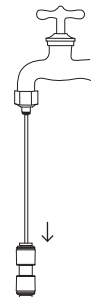

Insert the end of tap adaptor short tube into one end of the first hose connector as far as possible.

WATER CONNECTION

5

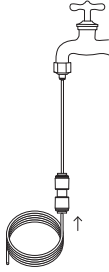

Insert one end of the water hose into the other end of hose connector as far as possible.

6

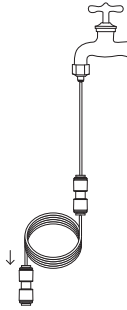

Insert the other end of the water hose into one end of the second hose connector as far as possible.

7

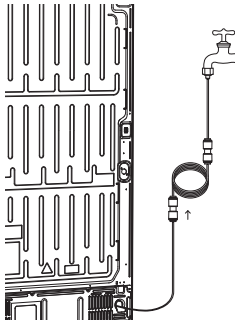

Connect the other end of the second hose connector to the hose attached to the back of the product.

Push the hose as far as possible into the connector.

8

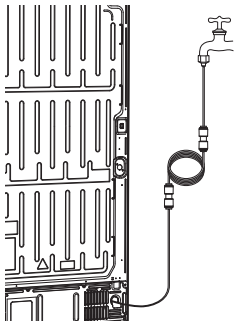

Check the connections, turn on the water supply and check for leaks.

FLUSHING THE WATER FILTER

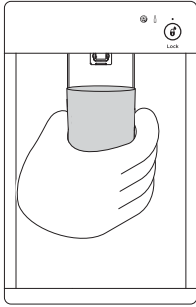

- ① Press the water dispenser pad to dispense 4L of water. Wait for four minutes before dispensing again.
- ② Dispense 4L of water and then wait for another four minutes. There may be carbon residue dispensed together with water. This is not harmful, and is normal during the flushing process.
- ③ Dispense another 4L of water. This prevents excessive dripping of water from your dispenser.

There may be a few drips of water coming out of the dispenser for a few days after installation. This is normal and occurs as the remaining trapped air is cleared from the system. Ensure your refrigerator has cooled for at least 2 hours before use.

POSITIONING YOUR REFRIGERATOR

Your Fisher & Paykel ActiveSmart™ refrigerator is fitted with front and rear rollers to allow you to easily move your refrigerator forward and backward. Avoid moving your refrigerator sideways to prevent damaging the rollers or the floor covering surface.

Your refrigerator will arrive with the front feet wound up to assist with moving the product into its final location.

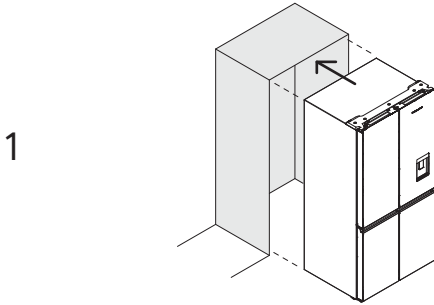

Roll the refrigerator into its final position ensuring there is the correct air gap between the product and surrounding cabinetry. See minimum clearance in cabinetry dimensions table.

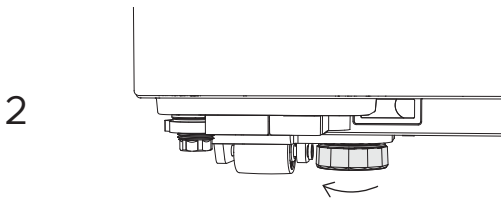

Adjust the front feet down until the refrigerator is leaning backward with the front approximately 10mm higher than the back. This will ensure a good door closing action.

Levelling of refrigerator doors

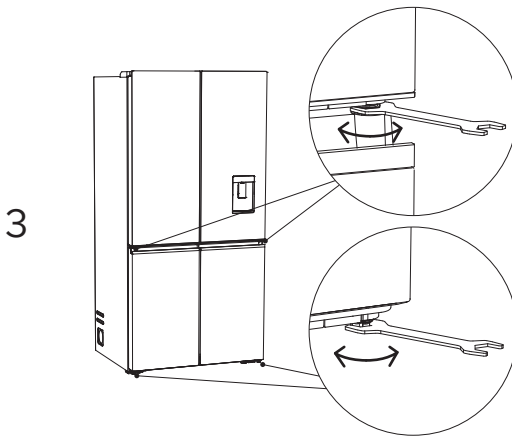

Using the spanner provided, turn the hinge anti-clockwise to lift the door or clockwise to drop the door.

The larger end of the spanner is for use on the bottom of the upper doors (centre hinges).

After adjustment on bottom hinges, ensure there is clearance between lower doors and centre hinge and doors swing freely.

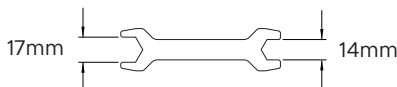

POSITIONING YOUR REFRIGERATOR

What to do if your product is unstable

1

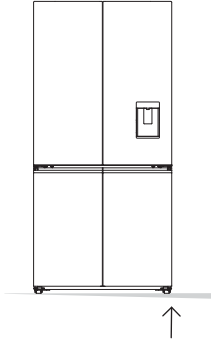

Gently push the refrigerator back until the rear rollers contact the floor.

Measure the gap under the front foot, which has come off the floor.

Obtain some solid packing material (hardwood, plastic, etc) which fits firmly into the gap under the foot.

2

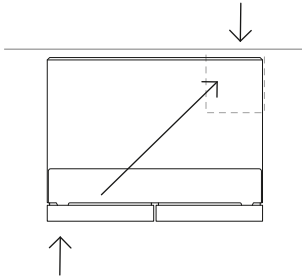

Wind both front feet up and roll the product out of position.

Place the packing material in the location diagonally opposite the front roller that lifts off the floor.

Ensure the packing material stays in place when the product is pushed back into position.

3

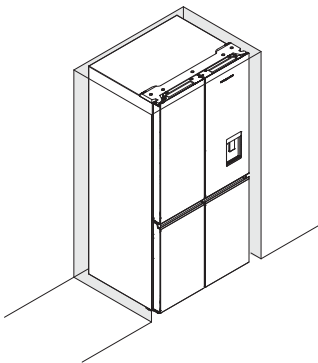

Roll the refrigerator back into position and adjust front feet. Check alignment and door closing action are satisfactory. Make small adjustments to the front feet where necessary.

COMPLETE INSTALLATION

Before placing food in the fridge or freezer compartments

- Remove all internal packaging. Ensure that all transit clips are removed from the refrigerator. These are small rubber stoppers located at the back of the shelves.
- Clean the inside of the appliance with a mix of warm water and a small amount of liquid detergent. Use a soft cloth to remove dust collected during manufacture and transport.
- Allow the refrigerator and freezer to run empty for 2–3 hours to allow each compartment to cool to the appropriate temperature.
- The appliance may have an odour on its initial operation, this will go when the refrigerator and freezer have cooled sufficiently.

FINAL CHECKLIST

TO BE COMPLETED BY THE INSTALLER

Ensure that:

- Check all parts are installed.
- Ensure the appliance is level.
- Ensure all internal and external packaging is removed from the appliance before use.
- Ensure the water filter is installed and has been flushed.

Complete and keep for safe reference:

Model _____

Serial No. _____

Purchase Date _____

Purchaser _____

Dealer Address _____

Installer's Name _____

Installer's Signature _____

Installation Company _____

Installation Date _____

FISHERPAYKEL.COM

© Fisher & Paykel Appliances 2026. All rights reserved.

The models shown in this guide may not be available in all markets
and are subject to change at any time.

The product specifications in this guide apply to the specific products and
models described at the date of issue. Under our policy of continuous product
improvement, these specifications may change at any time.

For current details about model and specification availability in your country,
please go to our website or contact your local Fisher & Paykel dealer.

431084C 05.26