

Haier

Built-in Side Opening Oven

60cm

INSTALLATION AND USER GUIDE

NZ AU

CONTENTS

SAFETY INSTRUCTIONS.....	3
HOW TO SAVE ENERGY	4
PACKAGING	4
DISPOSAL OF THE APPLIANCE	4
DESCRIPTION OF THE APPLIANCE.....	5
INSTALLATION.....	6
OPERATION	9
BAKING IN THE OVEN.....	19
CLEANING AND MAINTENANCE	25
OPERATION IN CASE OF EMERGANCY	28
TROUBLESHOOTING	28
TECHNICAL INFORMATION	29
MANUFACTURER'S WARRANTY.....	20
CUSTOMER CARE.....	31

SAFETY INSTRUCTIONS

- Mains lead of adjacent appliances may be damaged by hobs or stuck between the oven doors, and produce short circuit, therefore keep them at safe distance from the appliance.
- Do not use the oven in the event of a technical fault. If a technical fault occurs, disconnect the power and report the fault to the service centre for repair.
- Never clean the oven with the high-pressure steam cleaning device, as it may cause short a circuit.
- Do not use harsh abrasive cleaners, scourers or sharp metal scrapers to clean the door glass as they can scratch the surface which may result in glass shattering.
- The rules and provisions contained in this instruction manual should be strictly observed. Do not allow anybody who is not familiar with the contents of this instruction manual to operate the oven.
- If the supply cord is damaged, it must be replaced by the manufacturer, its service agent or similarly qualified persons in order to avoid a hazard.
- The appliance is not intended for use by persons (including children) with reduced physical, sensory or mental capabilities, or lack experience and knowledge, unless they have been given supervision for their safety.
- **WARNING:** Ensure that the appliance is switched off before replacing the lamp to avoid the possibility of ELECTRIC shock.
- When the input voltage exceeds 270V, the oven will automatically shutdown. The user will need to manually restart the oven.
- During unpacking, the packaging materials (polythene bags, polystyrene pieces, etc.) should be kept out of reach of children.
- Do not place aluminium foil, dishes or trays, water or ice on the oven floor during cooking, as doing so will irreversibly damage the enamel. Lining the oven with aluminium foil may even cause fire.
- During use the appliance becomes hot. Care should be taken to avoid touching heating elements inside the oven.
- **Warning:** Accessible parts may become hot during use. Young children should be kept away.
- Excess spillage must be removed before cleaning.
- The appliance must not be installed behind a decorative door in order to avoid overheating.
- Children should be supervised to ensure that they do not play with the appliance.
- The fixed wiring installation must be incorporated with an all poles disconnection device in accordance with the wiring rules that provide full disconnection under overvoltage category III conditions.

HOW TO SAVE ENERGY

Using energy in a responsible way not only saves money but also helps the environment. So, let's save energy, and this is how you can do it:

Make use of residual heat from the oven. If the cooking time is greater than 40 minutes, switch off the oven 10 minutes before the end time. When using the timer, set appropriately shorter cooking times according to the dish being prepared where possible.

Make sure the oven door is closed properly. Cooking residues/spillages left on the door seal can cause the door not to close with a tight seal, which can cause heat to escape from the oven. Clean up any spillages immediately.

PACKAGING



During transportation, protective packaging was used to protect the appliance against any damage. After unpacking, please dispose of all elements of packaging in a way that will not cause harm to the environment.

DISPOSAL OF THE APPLIANCE



Old appliances should not simply be disposed of with normal household waste, but should be delivered to a collection and recycling centre for electric/electronic equipment.

A symbol shown on the product, the instruction manual or the packaging shows that it is suitable for recycling.

Some materials used inside the appliance are recyclable. Recycling materials or other parts from used devices that will make a significant contribution to the protection of our environment if recycled appropriately. Information on appropriate disposal centres for used devices can be provided by your local authority.

DESCRIPTION OF THE APPLIANCE

HWOS60S4MB1

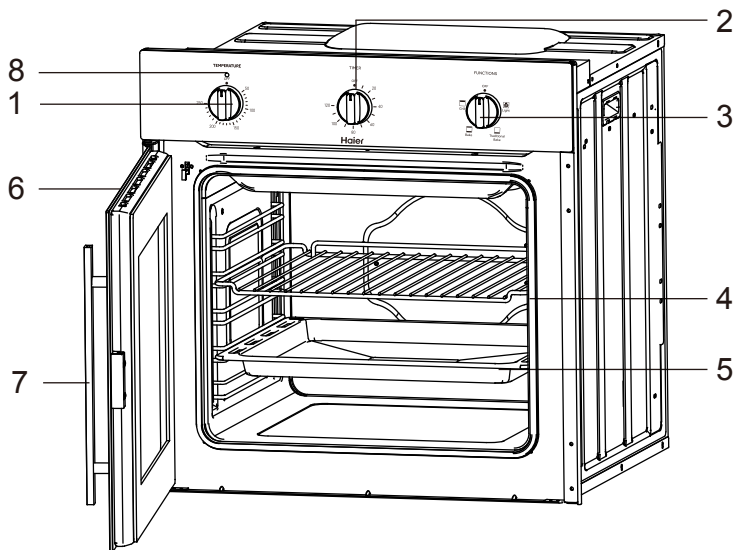

HWOS60S7EB1

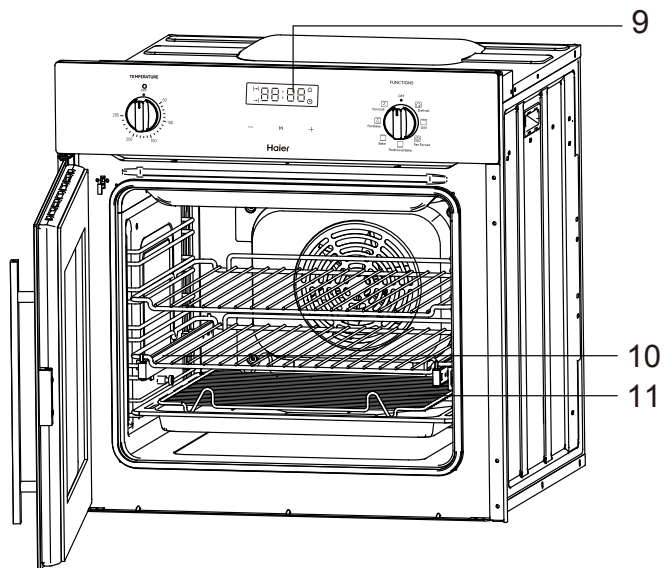

INSTALLATION

Number	Parts
1	Temperature Control Dial
2	Mechanical Timer
3	Oven Function Selection Dial
4	Wire Shelves
5	Baking Tray
6	Oven Door
7	Oven Door Handle
8	Oven Temperature Indicator
9	Electronic Programmer
10	Telescopic Rail
11	Grill Insert

Electrical Connections

Before connecting the oven to the mains power supply, check that:

- The domestic wiring system is suitable for the power drawn by the oven (as specified on the rating plate).
- The voltage corresponds to the value given on the rating plate.

Model	Max Power(W)	Frequency(Hz)	Voltage(V)	Amps(A)
HWO60S4MB1	2000W	50-60Hz	AC 220-240V	8.3-9.1
HWOS60S7EB1	2000W	50-60Hz	AC 220-240V	8.3-9.1

Installing The Oven

The kitchen should be dry and have effective ventilation according to the existing technical provisions.

Remove any packaging materials (foils, artificial foam, plastics nails, etc.) from the reach of children, because they represent potential danger. Children may swallow small parts, or suffocate with foils, plastics etc.

This is a built-in oven, which means that coating or veneer used on fitted cabinetry must be heat resistant in accordance with the relevant local standards. This prevents surface deformation for cabinetry. If you are unsure of your cabinetry's heat resistance, you should leave approximately 2cm of free space around the oven. The wall behind the oven should be resistant to high temperatures. During operation, the back of the oven can heat up to around 50 C above the ambient temperature.

Make an opening with the dimensions given in the diagram for the oven to be fitted.

Fully insert the oven into the opening, remove the four screws in the accessories bag, and use the screws to secure the oven to the cabinet in the positions shown.

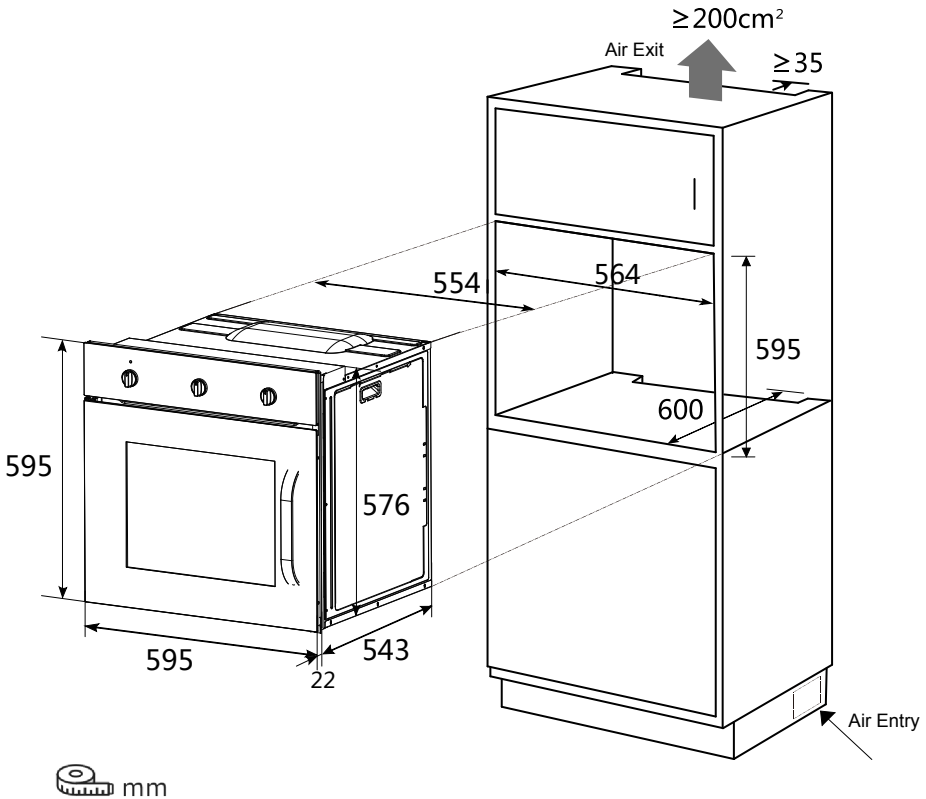

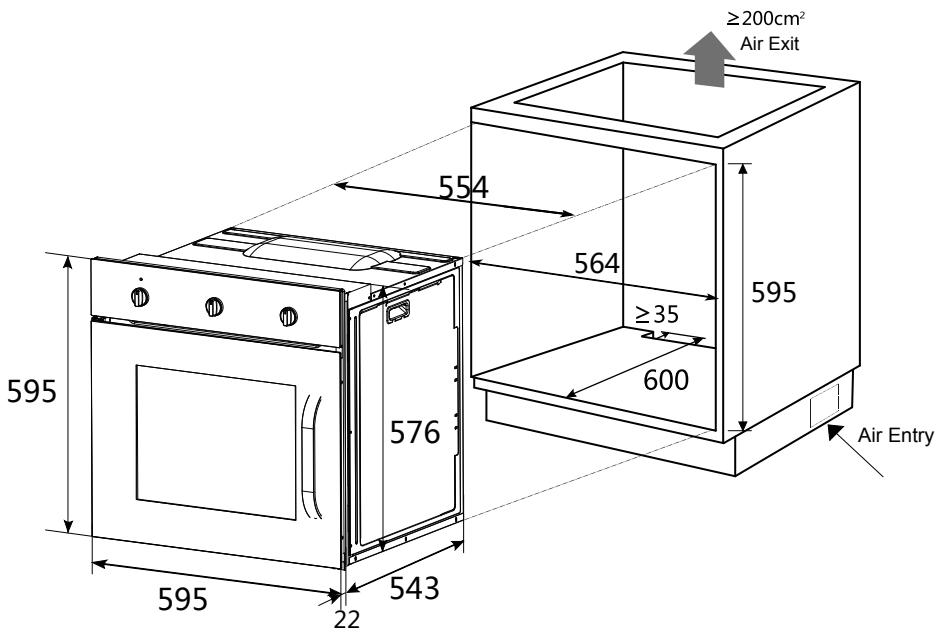

 mm

OPERATION

Before First Use

- Remove packaging, clean the interior of the oven with soft damp cloth and warm water and allow to dry.
- Take out and wash the oven accessories with warm water and a little washing-up liquid and dry thoroughly.
- Switch on the ventilation in the room or open a window.
- Heat the oven to a temperature of 250 °C, for approx. 30 minutes. Once the oven has cooled, wipe the inside of the oven with a soft damp cloth and allow to dry.

Caution!

When heating the oven for the first time, it is a normal phenomenon to see smoke and peculiar smells. These should disappear in about 30 minutes. Hence the importance of ventilation in the room during the process.

Control Panel

HWOS60S4MB1

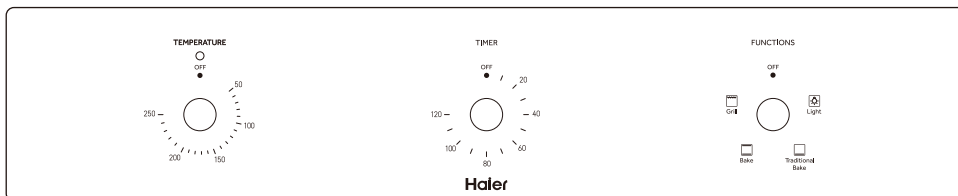

Cooking Functions

	Light		Traditional Bake
	Bake		Grill

HWOS60S7EB1

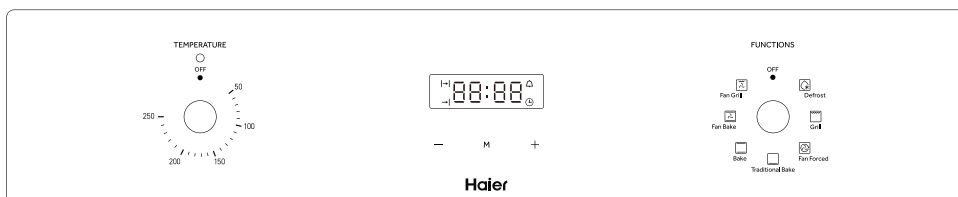

Cooking Functions

	Defrost		Grill
	Fan Forced		Traditional Bake
	Bake		Fan Bake
	Fan Grill		

Cook Function Operation

The oven is controlled by the function dial and the temperature control dial. To operate the oven, follow the instructions below:

1. Turn the function dial to the desired function.

HWOS60S4MB1

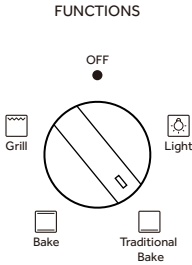

HWOS60S7EB1

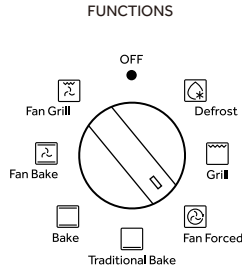

2. Turn the temperature dial to the desired cooking temperature.

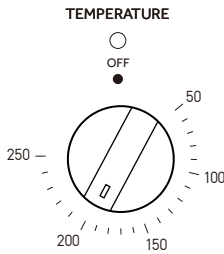

3. Set the minute timer to the desired cooking time.

HWOS60S4MB1

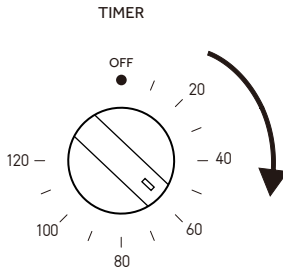

When the time is complete a bell will ring to indicate the end of the cooking period.

Note: The timer does not turn the oven off when the time is complete.

Caution!

When selecting any heating function, the oven will be switched on only after the temperature has been set by the temperature control dial.

3. Set the minute timer to the desired cooking time.

HWOS60S7EB1
Electronic programmer

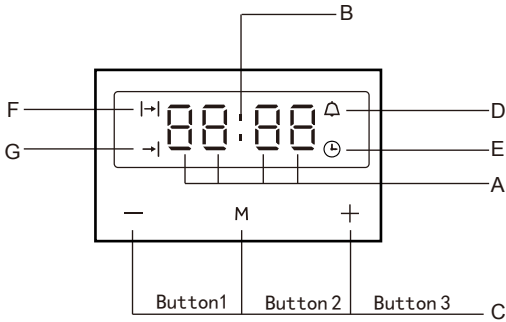

- | | |
|-------------------|--|
| A - Display field | F - Cooking time |
| B - Seconds Icon | G - End of cooking time |
| C - Buttons | M - Function |
| D - Timer | - - To decrease the numbers on the digital display |
| E - Current time | + - To increase the numbers on the digital display |

Setting the time

1. At power on, displayed "12.00" and  flashes.

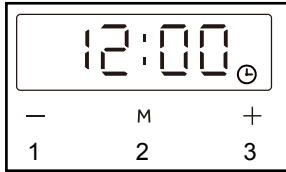

2. The current time can be set with button 1 and 3, 5 seconds after the time has been set, the new data will be saved.

The timer can be activated at any time and any function. The timer can be set from 1 minute to 23 hours and 59 minutes.

You should:

1. Press button 2, flashing . Enter the timer setting.

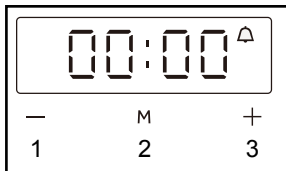

2. Set the timer using buttons 1 and 3.

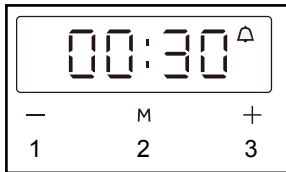

3.5 seconds after the time is set, or directly press the button 2, the signal function  is on. your setting is saved.

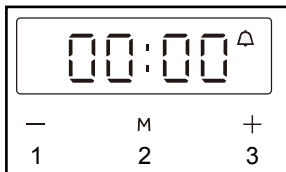

4. When the set time is up the alarm signal will be activated and the signal function  starts flashing again.

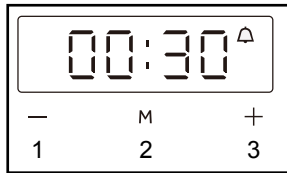



5. Press any button, the signal function  and alarm signal will go off. Or the alarm signal will be turned off automatically after 2 minutes.

Caution!

Besides timer alarm, any other alarms can be turned off by pressing any button. If the alarm signal is not turned off manually, it will be turned off automatically after 2 minutes.

Semi-automatic operation

If the oven is to be switched off at a given time, or after a defined period, you should:

1. Set the oven function knob and the temperature regulator knob to the setting at which you want the oven to operate.
2. Press the function button, the oven will begin to work and the function signal  flashing.
3. Press button 1 or 3 to adjust the cooking time, within a range from 1 minute to 10 hours.
4. Or press button "MODE" twice. Then the display will show flashing . Set the end time by buttons 1 and 3.
5. The set time is introduced to the memory after 5 seconds.
6. When the set time passes, the oven is switched off automatically, the alarm is activated.
7. Press any button, the alarm signal and the  icon will go off, or the alarm signal will be turned off automatically after 2 minutes.

Caution!

When using the semi-automatic operation, set either the cooking time or the end of cooking time.

If you set the cooking time to 0 or set the end of cooking time to the current time, the auto function will be off.

After the auto function is off, the cooking time to 0, end of cooking time and current time remains the same.

For example:

The current time is 2:00, want to oven work of 3 hours, end of cooking time is set to be 5:00(2:00+3:00= 5:00).

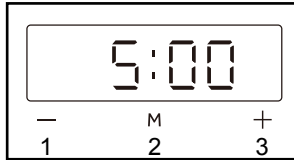

There are two methods to achieve this setting:

First method:

1. Set the cooking time using buttons 1 and 3.

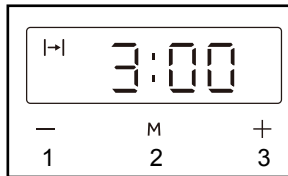

2. End of cooking time automatically change to 5:00.

Second method:

1. Set the end of cooking time using buttons 1 and 3.

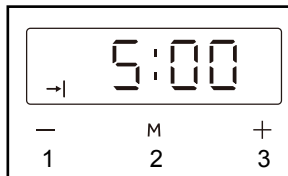

2. Cooking time automatically change to 3:00. 5 seconds after the setting, the auto function is on. 3 hours later, the current time shows "5:00" The alarm signal is activated.

Automatic operation

If the oven is to be switched on for a specified period of time and switched off at a fixed hour then you should set the cooking time and the end of cooking time:

1. Set the oven function knob and the temperature regulator knob to the setting at which you want the oven to operate.
2. Press button 2, the oven will begin to work and the function signal |→| flashing.

3. Press button 1 or 3 to adjust the cook time, within a range from 1 minute to 10 hours.
4. And press button 2. then the display will show flashing $\rightarrow|$.Set the cooking time using buttons 1 and 3 .
5. The set time is introduced to the memory after 5 seconds, the $| \rightarrow|$ and $\rightarrow|$ always on.
6. When the set time passed ,the oven is switched off automatically, the alarm is activated, and the $| \rightarrow|$ will go off.
7. Press any button, the alarm signal and the $\rightarrow|$ icon will go off, Or the alarm signal will be turned off automatically after 2 minutes.

For example:

If the current time is 2:00; cooking time set to be 3 hours ;
 end of cooking time set to be 10:00, the work time will be 7:00 (7:00=10:00-3:00).

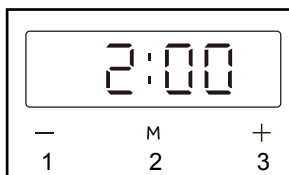

1. Set the cooking time to be "3.00" with buttons 1 and 3.

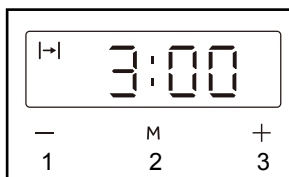

2. Set the end of cooking time.time to be "10.00 " with buttons 1 and 3.

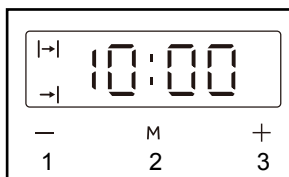

3. 5 seconds after setting, the autofunction is on.

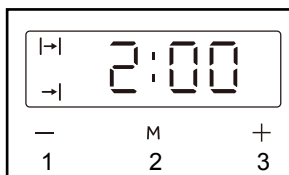

4. When it up to 7:00 , the oven will begin to work.

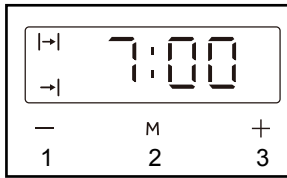

5. When it up to 10:00 , the alarm signal is activated.The oven is switched off automatically.

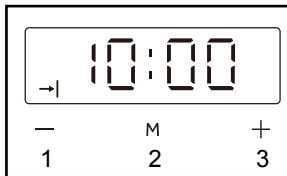

Caution!

At least more than one minute cooking time, cooking time and end of cooking time must be set.

If the cooking time set to be 0 or the end of cooking time set to be the current time, the auto function will be off.

After the auto function be off,the cooking time to 0,end of cooking time and current time remains the same

The cooking time,waiting time and end of cooking time range:

Cooking time range: $0 < t \leq 10$ hours

End of cooking time range:

current time $<$ end of cooking time \leq current time + waiting time + cooking time

Waiting time = end of cooking time - cookingtime

Note: After the oven is powered on for the first time, it is necessary to set or confirm the clock, so that the oven heating function can operate normally.

Cooking Functions

HWOS60S4MB1



Light

By setting the dial to this position the lighting inside the oven is switched on.

Caution!

At this oven function dial position. The oven is not being warmed up.



Traditional Bake

This function uses only the lower heating element. It is particularly suitable for quiches, pies and slices that require more cooking on the bottom.



Bake

This function uses the upper and lower heating elements, creating a natural convection oven. Bake creates a perfect cooking zone in the centre of the oven, ideal for pastry, bread and cakes.



Grill

Use this function to grill or brown small amounts of food. Locate the grill pan in the 4th shelf positions. Pre-heat the grill for 5 minutes before use.

HWOS60S7EB1



Defrost

Using the fan with lower heater, this oven function circulates the air around the oven cavity, speeding up the natural defrost process.



Grill

Use this function to grill or brown small amounts of food. Locate the grill pan in the 4th shelf positions. Pre-heat the grill for 5 minutes before use.



Fan Forced

Use this function to grill or brown small amounts of food. Locate the grill pan in the 4th shelf positions. Pre-heat the grill for 5 minutes before use.



Traditional Bake

This function uses only the lower heating element. It is particularly suitable for quiches, pies and slices that require more cooking on the bottom.



Bake

This function uses the upper and lower heating elements, creating a natural convection oven. Bake creates a perfect cooking zone in the centre of the oven, ideal for pastry, bread and cakes.



Fan Bake

Using the top and bottom elements and the fan, this cooking function distributes the heat around the oven to give an even temperature throughout.



Fan Grill

When the knob is turned to this position, the oven activates the grill and fan function. In practice, this function allows the grilling process to be speeded up and an improvement in the taste of the dish, you should only use the grill with the oven door shut.

Oven Shelf Guide Levels

Baking pans and accessories (oven grid, baking tray, etc) may be inserted into the oven in any of the 5 guiding levels. Appropriate levels are indicated in the tables that follow.

Always count levels from the bottom upwards.

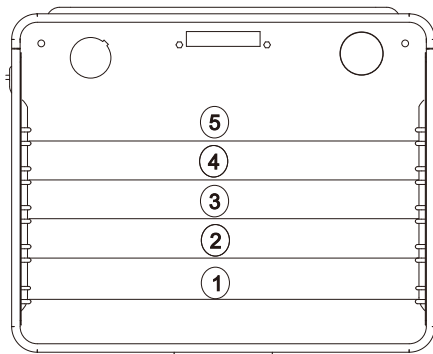

BAKING IN THE OVEN

Please note:

The cooking advice given in the following tables is approximate and can be adjusted based on your previous experience and cooking preferences.

If the required cake type is not listed, refer to the one most similar to it.

Baking

Use the bake functions for best results.

Always place the baking dishes onto the wire shelves. Only remove the shelf if baking in the flat biscuit tray supplied with the oven.

Do not put the cake in the oven until it has finished preheating.

Baking tips

Is the cake cooked all the way through?

Pierce the cake with a wooden skewer at the thickest part, if the dough does not stick to it, the cake is cooked all the way through.

Cake has collapsed

Check the recipe. You may need to use smaller quantity of liquid components next time.

Ensure mixing times are followed, especially when using electric mixers, to ensure the right consistency is achieved.

Cake is too light on the bottom

Try baking one level lower next time.

Please note:

The temperature ranges and baking times given in the tables are indicative. We recommend selecting the lower temperature to begin with and increasing it in the later stages of cooking if required.

Baking Table

Food Type	Shelf Level (See Oven Shelf Guide Levels)	Temperature (°C) 	Baking Time (Minutes)
Sweet			
Cheesecake (Tart form)	2	180-190	60-80
Fruit cake	2	190-200	50-70
Sponge cake	2	180-190	30-40
Cherry cake	3	190-210	30-50
Chocolate Cake	2	160-180	50-60
Jelly roll	3	190-200	15-25
Apple pie	2	190-210	40-60
Puff pastry	2	180-190	20-30
Biscuits	3	180-190	20-30
Danish pastry	3	190-210	20-35
Flaky pastry	3	200-210	20-30
Profiterole	3	190-210	25-45
Savoury			
Bacon roll	2	190-200	45-60
Pizza	2	220-240	30-45
Bread Loaf	2	200-220	50-60
Bread Rolls	2	210-230	30-40
Caraway roll	3	180-190	15-25
Cooked from Frozen			
Apple pie	2	190-210	50-70
Pizza	2	210-230	20-30
Oven chips	2	210-230	20-35

Roasting

Use the bake oven function for best results.

Roasting tips

For best results, use light enamel trays, oven proof glassware, clay or cast-iron cookware. Covering your roast or wrapping it in foil will preserve the juices as well as keep the oven clean.

Leaving the roast uncovered will result in shorter cooking time.

Please note:

The temperature ranges and roasting times given in the tables are indicative and will vary depending on the type, size and quality of the meat.

Roasting large pieces of meat can produce excessive steaming and condensation on the oven door. This is normal and does not affect the operation of the oven. Once you have finished cooking a roast, ensure you wipe the oven door and glass thoroughly.

The roast should be checked regularly and turned half-way through cooking.

When roasting on the grill grid, ensure the grid sits properly within the oven tray to catch the dripping juices and fat.

Never leave the roast to cool in the oven as it might produce condensation which in turn can cause corrosion of the oven.

Roasting Table

Type of Meat	Weight (Grams)	Shelf Level (See Oven Shelf Guide Levels)	Temperature (°C) 	Roasting Time (Minutes)
Beef				
Beef Loin	1000	2	210-230	40-80
Roast Beef	1000	2	230-240	30-40
Pork				
Pork roast with skin	1500	2	190-200	90-135
Pork cutlet	1500	2	190-210	100-120
Lamb				
Bone in Leg	1500	2	160-170	60-90
Boneless Leg	1500	2	160-170	60-140
Poultry				
Whole Chicken	1200	2	210-220	60-70
Whole Chicken	1500	2	210-220	70-90
Duck	1700	2	190-210	120-150
Goose	4000	2	170-180	180-200
Turkey	5000	2	160-170	180-240
Fish				
Whole Fish	1000	2	210-220	50-60
Fish Souffle	1500	2	190-210	50-70

Grilling

Intensive heat from the infrared element makes the oven and its accessories extremely hot. Use oven gloves and appropriate grilling utensils.

To avoid coming into contact with hot grease which could cause injuries, use long grill tongs when handling the grilled foods.

The grill must be supervised at all times. Excessive heat can quickly burn your food which poses a fire risk.

Do not allow children in the vicinity of the grill when it's in operation.

Grilling is ideal for low-fat sausages, meat, fish fillets and steaks as well as for browning or crisping dishes.

Grilling tips

Please note:

The temperature and grilling times given in the tables are indicative and will vary depending on the type, size and quality of the meat.

Grilling must be carried out with the oven door closed.

Grill element should be preheated for 5 minutes. Oil trays before placing food on it to avoid food sticking to the grid. Place the grid into the oven tray which will catch the dripping fat and juices.

Turn the meat half-way through cooking. Smaller pieces of meat will require just one turn whereas larger pieces of meat may need turning more. Always use appropriate tongs for handling the meat.

Clean the oven and its accessories thoroughly after each use to ensure longevity of your appliance.

Grilling Table

Type of Meat	Weight (Grams)	Shelf Level (See Oven Shelf Guide Levels)	Temperature (°C) 	Grilling Time (Minutes)
Meat and sausages				
2 Beefsteaks (Rare)	400	5	240	14-16
2 Beefsteaks (Medium)	400	5	240	16-20
2 Beefsteaks (Well done)	400	5	240	20-23
2 Pork Chops	400	5	240	20-23
4 Lamb Cutlets	700	5	240	15-18
4 Grill Sausages	400	5	240	9-14
1 Chicken (Halved)	1400	3	240-250	28-33(one side) 23-28(other side)
Fish				
Salmon Fillets	400	4	240	19-22
Fish in aluminium foil	500	4	230	10-13
Toast				
White bread	200	4	240	1.5-3
Wholemeal bread	200	4	240	2-3
Toasted Sandwich	600	4	240	4-7
Meat/Poultry				
Chicken	1000	3	180-200	60-70
Roast Pork	1500	3	160-180	90-120
Roast Beef	1500	3	190-200	40-100

CLEANING AND MAINTENANCE

By ensuring proper cleaning and maintenance of your oven you can have a significant influence on the continuing fault-free operation of your appliance.

Before you start cleaning, the oven must be switched off and you should ensure that all knobs are set to the "OFF" position. Do not start cleaning until the oven has completely cooled.

Cleaning the Oven

- The oven should be cleaned after each use.
- Allow the oven to cool completely before carrying out any cleaning or maintenance.
- Steam cleaners must not be used when cleaning this appliance.
- The oven cavity should be cleaned using a mild detergent solution and warm water then wiped dry with a suitable, clean cloth.
- Abrasive cleaning agents or scouring pads/cloths should not be used as they can damage the oven.

Steam Cleaning

- Pour 250ml of water into a bowl placed in the oven on the first level.
- Close the oven door
- Use the "Traditional Bake" function and set the temperature to 100°C.
- Heat the oven for 30 minutes.
- Open the oven door and wipe the cavity with a clean cloth or sponge and wash with a solution of mild detergent and warm water.
- Dry the oven thoroughly.

Replacing the oven light bulb

Before any maintenance is started involving electrical parts, the appliance must be disconnected from the power supply.

If the oven has been in use, let the oven cavity and the heating elements cool down before attempting any maintenance.

Changing the bulb

1. Unscrew the glass protective cover. Once removed, we recommend washing and drying the cover before replacing it.
2. Carefully remove the old bulb and insert the new bulb suitable for high temperatures having the following specifications : 220-240V/50Hz,25W,G9 fitting.
3. Replace the protective cover.

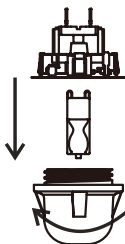

IMPORTANT

- Never use screwdrivers or other utensils to remove the light cover. This could damage the enamel of the oven or the lamp-holder. Remove only by hand.
- Never replace the bulb with bare hands as contamination from your fingers can cause premature failure. Always use a clean cloth or gloves.

PLEASE NOTE

The bulb replacement is not covered by your guarantee/warranty

Door Removal

This oven can be converted from left hand hinged to right hand hinged, if necessary. Door reversal should be performed as part of the oven installation.

- Fully open the door.
- Remove the four A fixing screws from the door hinge.
- Rest the door on a soft surface.
- Remove the four B fixing screws from the trim plate and remove the trim plate.
- Turn the trim plate 180° and reattach it on the opposite side using the four B fixing screws.
- Turn the door 180°.
- Secure the door in its new position using the four A fixing screws.

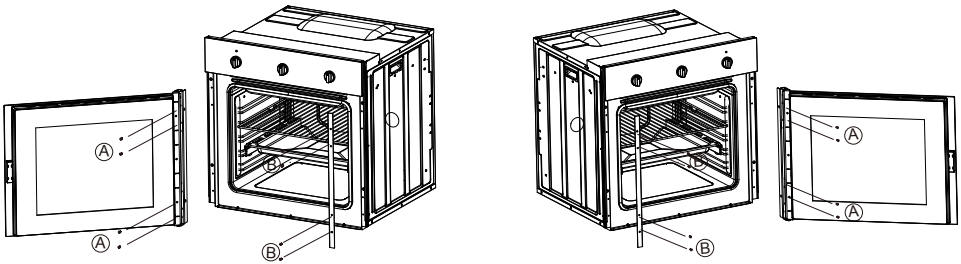

Please Note

Ensure that the pivot pins and trim plate are correctly in position, and that the oven door can be closed and opened.

Removing the Oven Door Inner Glass

The oven door inner glass can be removed to facilitate cleaning.

- Fully open the door.
- Remove the four A fixing screws from the door hinge.
- Rest the door on a soft surface.
- Use a screwdriver to prise the inner glass from the frame.
- Move the inner glass towards the hinged side, then lift the glass to remove it from the frame.

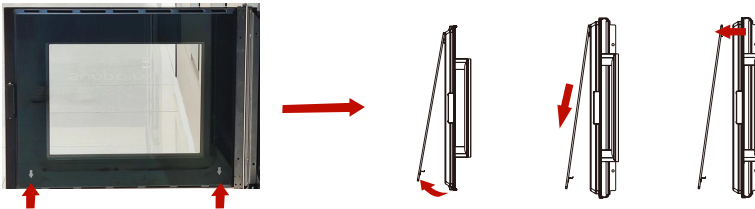

To replace the inner door glass, repeat the above steps in reverse order.

OPERATION IN CASE OF Emergency

In the event of an emergency, you should:



- Switch off all working units of the oven.
- Call the service centre.

TROUBLESHOOTING

Some minor faults can be fixed by referring to the instructions given in the table below. Before calling the customer support centre or the service centre check the following points that are presented in the table.

Problem	Reason	Actions
1. The appliance does not work	Break in the power supply	Check the household fuse box. If there is a blown fuse replace it with a new one.
	Choose wrong function	Check if the function dial and temperature dial are set to the correct positions.
2. The oven lighting does not work	The bulb is loose or damaged	Tighten up or replace the blown bulb (see cleaning and maintenance).

TECHNICAL INFORMATION

Model	HWOS60S4MB1	HWOS60S7EB1
Rated voltage	AC220-240V	AC220-240V
Rated frequency	50-60Hz	50-60Hz
Rated power	2000W	2000W
Top element	850W	850W
Grill element	1100W	1100W
Bottom element	1150W	1150W
Circular element		1600W
Fan		•
Volume	60L	59L
Product Dimensions (DXWXH)	565x595x595	565x595x595

MANUFACTURER'S WARRANTY

Please read this warranty card carefully. Attach your purchase receipt to this warranty card and keep in a safe place. You must produce both warranty card and proof of purchase in the event of a warranty repair being required.

When you purchase any new Haier Product you automatically receive a two year Manufacturer's Warranty covering parts and labour for servicing.

The Manufacturer undertakes to:

Repair or, at its option, replace without cost to the owner either for material or labour any part of the Product, the serial number of which appears on the Product, which is found to be defective within TWO YEARS from the date of purchase.

This warranty DOES NOT cover:

- A** Service calls which are not related to any defect in the Product. The cost of a service call will be charged if the problem is not found to be a Product related fault. For example:
1. Correct the installation of the product.
 2. Provide Instruction on use of the product or change the setup of the product.
 3. Replace house fuses or correct house wiring.
 4. Correcting fault(s) caused by the user.
 5. Noise or vibration that is considered normal.
 6. Water on the floor due to incorrect loading or excessive suds.
 7. Blocked pumps, removal of foreign objects/substances from the machine, including the pump and inlet house filters.
 8. Correcting damage caused by pests, eg. rats, cockroaches etc.
 9. Correct corrosion or discolouration due to chemical attack.
 10. Power outages or surges
- B** Defects caused by factors other than:
1. Normal domestic use or
 2. Use in accordance with the Product's User Guide.
- C** Defects to the Product caused by accident, neglect, misuse or 'Act of God'.
- D** The cost of repairs carried out by non-authorized repairers or the cost of correcting such unauthorised repairs.
- E** Normal recommended maintenance as set out in the Product's User Guide.
- F** Repairs when the appliance has been dismantled, repaired or serviced by other than an AUTHORISED CUSTOMER SERVICE CENTRE or the selling dealer.
- G** Pick up and delivery.
- H** Transportation or travelling costs involved in the repair when the product is installed outside the AUTHORISED CUSTOMER SERVICE CENTRE'S normal service area.

This product has been designed for use in a normal domestic environment. It is not intended for commercial use. Doing so may affect product warranty. Service under this warranty must be provided by an Authorised Service Repairer (refer to the Customer Care section for contact details). Such service shall be provided during normal business hours. This warranty certificate should be shown when making any claim.

Note:

This Warranty is an extra benefit and does not affect your legal rights and applies only to product purchased in New Zealand and Australia. Please keep this Warranty Card in a safe place.

For Australian customers:

Our goods come with guarantees that cannot be excluded under the Australian Consumer Law. You are entitled to a replacement or refund for a major failure and for compensation for any other reasonably foreseeable loss

CUSTOMER CARE

Check the things you can do yourself. Refer to your User Guide and check:

1. Your appliance is correctly installed.
2. You are familiar with its normal operation.
3. You have read the problem solving section in your User Guide.

If after checking these points you still need assistance, please refer to your nearest Haier Authorised Repairer.

In New Zealand, if you need assistance...*

Call your retailer who is trained to provide information on your appliance, or if we can be of any further help, please contact our Customer Care Centre:

Toll Free: 0800 372 273 Fax: (09) 273 0656

Email: customer.care@haier.co.nz

Postal address: P.O. Box 58732, Botany, Manukau 2163

If you need service...*

We have a network of independent Fisher & Paykel Authorised Repairers whose fully trained technicians can carry out any service necessary on your appliance. Your dealer or our Customer Care Centre can recommend a Fisher & Paykel Authorised Repairer in your area.

In Australia, if you need assistance...*

Call the Customer Care Centre and talk to one of our Customer Care Consultants.

Toll Free: 1300 729 948 Fax: (07) 3826 9298

Email: customer.care@haierlife.com.au

Postal Address: PO Box 798, Cleveland QLD 4163

If you need service...*

We have a network of qualified Authorised Repairers whose fully trained technicians can carry out any service necessary on your appliance. Our Customer Care Centre can recommend an Authorised Repairer in your area.

*If you call or write, please provide: name, address, model number, serial number, date of purchase and a description of the problem. This information is needed in order to better respond to your request for assistance.

Product Details

Model _____ Serial No. _____

Date of

Purchase _____ Purchaser _____

Dealer _____

Suburb _____

Town _____

Country _____

Thank you for choosing Haier. We are confident that you will enjoy many years of good service from your appliance.