

INDUCTION COOKTOPS

PLANNING GUIDE

SERIES 7

36" | C1365ZZDTB5

30" | C1304ZDTB5

24" | C1244ZZDTB5

12" | C1122ZDTB5

FISHER & PAYKEL

INTRODUCTION

This comprehensive planning guide provides you with the framework and tools to achieve your desired design outcome with Fisher & Paykel appliances. In this guide, you will find a range of conceptual, detailed, and dimensional product information to bring your ideas to life and create spaces that truly reflect your vision.

SUPPORT

For additional design planning and installation support please contact the Fisher & Paykel design support team.
designsupport@fisherpaykel.com

NOTES

The models shown in this Planning Guide may not be available in all markets and are subject to change at any time. Refer to our website fisherpaykel.com for the latest document version. Product specifications may vary from those shown. This Planning Guide should not be used as installation guidance for any product. Specific installation guidance will be available with the product on delivery and on our website.

CONTENTS

CONCEPT DESIGN		PAGE	DEVELOPED AND DETAILED DESIGN		PAGE	DEVELOPED AND DETAILED DESIGN		PAGE
Design choices			Data sheets			Services		
Cooktop models		4	CI365ZZDTB5		11	Power requirements		19
Specification Guide			CI304ZDTB5		12			
36" CI365ZZDTB5		6	CI244ZZDTB5		13			
30" CI304ZDTB5		7	CI122ZDTB5		14			
24" CI244ZZDTB5		8	Planning considerations					
12" CI122ZDTB5		9	Cutout dimensions - proud and flush		16			
			Ventilation and clearances		17			

DESIGN CHOICES

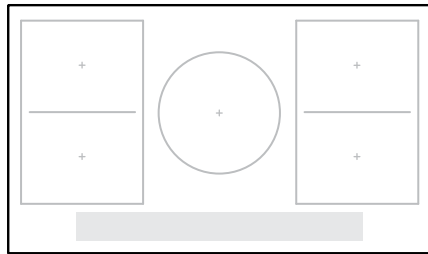
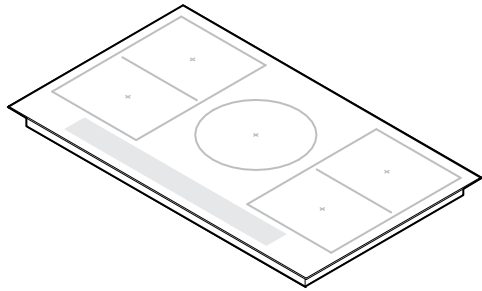

36" 5 ZONE INDUCTION COOKTOP, 2 SMARTZONES

Model no:
 CI365ZZDTB5 Black
 35 7/16W x 20 7/8D x 3 9/16H

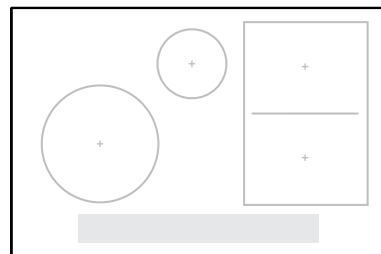
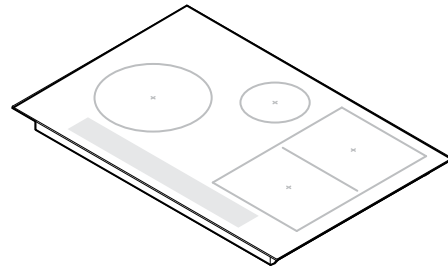

30" 4 ZONE INDUCTION COOKTOP, 2 SMARTZONES

Model no:
 CI304ZDTB5 Black
 29 15/16W x 20 7/8D x 3 9/16H

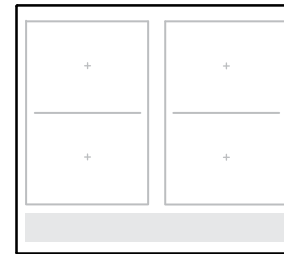
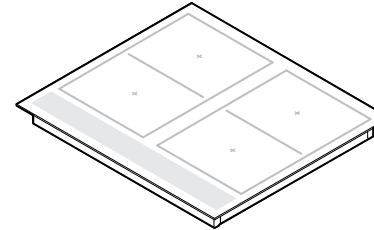

24" 4 ZONE INDUCTION COOKTOP, 2 SMARTZONES

Model no:
 CI244ZZDTB5 Black
 23 5/8W x 20 7/8D x 3 9/16H

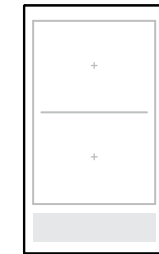
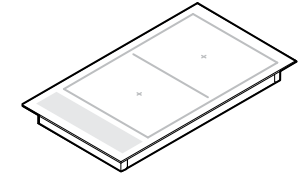

12" 2 ZONE INDUCTION COOKTOP, 1 SMARTZONE

Model no:
 CI122ZDTB5 Black
 11 13/16W x 20 7/8D x 2 7/16H

The models shown in this Planning Guide may not be available in all markets and are subject to change at any time. Product specifications may vary from those shown. This Planning Guide should not be used as installation guidance for any product. Further information is required to safely and correctly install the products featured here. Specific installation guidance will be available with the product on delivery and on our website fisherpaykel.com

SPECIFICATION GUIDE

**OVERVIEW**

This 36" induction cooktop offers expansive cooking flexibility with a clean, modern aesthetic. Install flush or slightly raised from the countertop for design freedom.

Five cooking zones, including two SmartZones, can be linked to accommodate larger cookware.

Touch&Slide controls provide precise temperature adjustments, while induction delivers fast heat response and accurate control.

PRODUCT***CI365ZZDTB5**

36", Black, 5 Zone Induction Cooktop, SmartZone

*Some models may not be available in all markets, please check fisherpaykel.com for more information.

FEATURES

- ① Install flush or raised with the countertop for complete design freedom
- ② Touch&Slide controls for quick, accurate temperature adjustments
- ③ Five cooking zones, with SmartZone linking to create a larger cooking surface
- ④ Induction delivers instant heat response and precise control across all temperatures
- ⑤ Gentle Heat functions for delicate cooking tasks
- ⑥ Surface stays cool unless cookware is detected, for added peace of mind
- ⑦ Spills won't bake on, making the cooktop quick and easy to clean
- ⑧ Induction wastes less heat by heating only the cookware, not the cooktop surface



OVERVIEW

This 30" induction cooktop offers flexibility and precision with a clean, modern aesthetic. Install flush or slightly raised from the countertop for design freedom.

Four cooking zones with SmartZone linking accommodate larger cookware.

Touch&Slide controls respond instantly for precise temperature adjustments, while induction delivers fast heat response and accurate control.

PRODUCT*

CI304ZDTB5

30", Black, 4 Zone Induction Cooktop, SmartZone

*Some models may not be available in all markets, please check fisherpaykel.com for more information.

FEATURES

- ① Install flush or raised with the countertop for complete design freedom
- ② Touch&Slide controls for quick, accurate temperature adjustments
- ③ Four cooking zones, with SmartZone linking to create a larger cooking surface
- ④ Induction delivers instant heat response and precise control across all temperatures
- ⑤ Gentle Heat functions for delicate cooking tasks
- ⑥ Surface stays cool unless cookware is detected, for added peace of mind
- ⑦ Spills won't bake on, making the cooktop quick and easy to clean
- ⑧ Induction wastes less heat by heating only the cookware, not the cooktop surface

The models shown in this Planning Guide may not be available in all markets and are subject to change at any time. Product specifications may vary from those shown. This Planning Guide should not be used as installation guidance for any product. Further information is required to safely and correctly install the products featured here. Specific installation guidance will be available with the product on delivery and on our website fisherpaykel.com



OVERVIEW

This 24" induction cooktop integrates seamlessly into any kitchen, with the option to install flush or slightly raised from the countertop for design freedom.

Four cooking zones with SmartZone linking accommodate larger cookware.

Touch&Slide controls provide precise adjustments, while induction technology delivers fast heat response, accurate control, and Gentle Heat for delicate tasks.

PRODUCT*

CI244ZZDTB5

24", Black, 4 Zone Induction Cooktop, SmartZone

*Some models may not be available in all markets, please check fisherpaykel.com for more information.

FEATURES

- ① Install flush or raised with the countertop for complete design freedom
- ② Touch&Slide controls for quick, accurate temperature adjustments
- ③ Four cooking zones, with SmartZone linking to create a larger cooking surface
- ④ Induction delivers instant heat response and precise control across all temperatures
- ⑤ Gentle Heat functions for delicate cooking tasks
- ⑥ Surface stays cool unless cookware is detected, for added peace of mind
- ⑦ Spills won't bake on, making the cooktop quick and easy to clean
- ⑧ Induction wastes less heat by heating only the cookware, not the cooktop surface

The models shown in this Planning Guide may not be available in all markets and are subject to change at any time. Product specifications may vary from those shown. This Planning Guide should not be used as installation guidance for any product. Further information is required to safely and correctly install the products featured here. Specific installation guidance will be available with the product on delivery and on our website fisherpaykel.com



OVERVIEW

This 12" induction cooktop delivers flexibility and precision in a compact form. Install flush or slightly raised from the countertop to suit your kitchen design.

Two cooking zones with SmartZone linking accommodate larger cookware.

Touch&Slide controls offer precise adjustments, while induction technology provides fast heat response, accurate control, and Gentle Heat for delicate tasks.

PRODUCT*

CI122ZDTB5

12", Black, 2 Zone Induction Cooktop, SmartZone

*Some models may not be available in all markets, please check fisherpaykel.com for more information.

FEATURES

- ① Install flush or raised with the countertop for complete design freedom
- ② Touch&Slide controls for quick, accurate temperature adjustments
- ③ Link two cooking zones with SmartZone to accommodate larger cookware
- ④ Induction delivers instant heat response and precise control across all temperatures
- ⑤ Gentle Heat functions for delicate cooking tasks
- ⑥ Surface stays cool unless cookware is detected, for added peace of mind
- ⑦ Spills won't bake on, making the cooktop quick and easy to clean
- ⑧ Induction wastes less heat by heating only the cookware, not the cooktop surface

DATA SHEETS

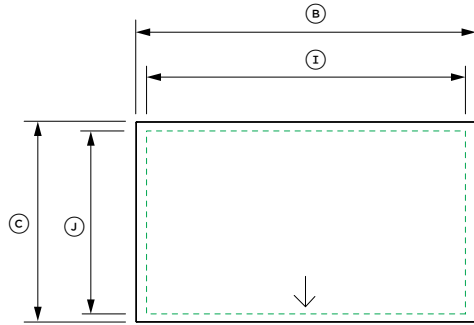

PLAN VIEW

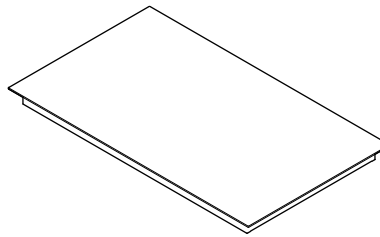

ISOMETRIC VIEW

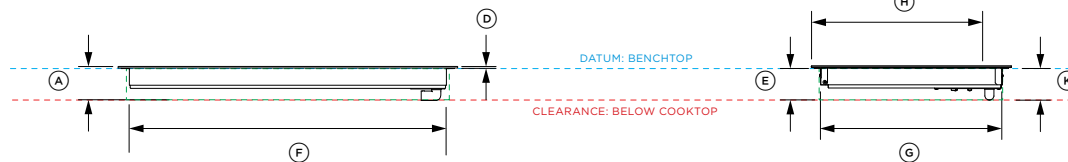

FRONT VIEW

SIDE VIEW

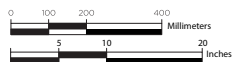

Model no:

CI365ZZDTB5

Product Dimensions

	in	mm
(A) Overall height of product (includes glass)	3 9/16	90
(B) Overall width of product	35 7/16	900
(C) Overall depth of product	20 7/8	530
(D) Glass height	5/32	4
(E) Chassis height (excluding glass)	3 3/8	86
(F) Chassis width	33 1/4	845
(G) Chassis depth	19 1/8	485
(H) Distance from front of cooktop glass to conduit	17 1/2	445

Cutout Dimensions

	in	mm
(I) Minimum width	33 1/2	850
(J) Minimum depth	19 5/16	490
(K) Minimum height*	3 9/16	90

Minimum Clearances

	in	mm
Sides of cutout to combustible material	1 3/16	30
Back of cutout to combustible surface	1 9/16	39
Front of cutout to counter edge	1 3/8	35
Cooktop to overhead rangehood or cabinetry	25 19/32	650
Appliances or cabinetry below countertop*	3 9/16	90
Maximum depth of cabinetry over cooktop	13	330
Maximum width of cabinetry over cooktop	35 7/16	900

Weight

	lb	kg
Packaged	36.4	16.5
Unpackaged	31	14

*Check the ventilation and clearances on page 17 for cutout height options

NOTE: Ventilation is required for cooktops

INDICATES CABINERY / PRODUCT DATUM -----
 INDICATES CABINERY CLEARANCES -----
 INDICATES CUTOUT -----

IMPORTANT NOTE: Throughout this guide, dimensions may vary by ±2mm (1/16"). Please read the installation manual for detailed information on installing the product. For full installation instructions & specifications visit fisherpaykel.com

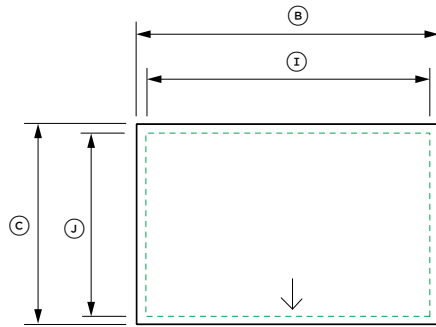

PLAN VIEW

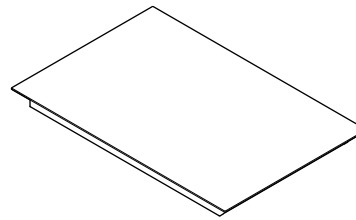

ISOMETRIC VIEW

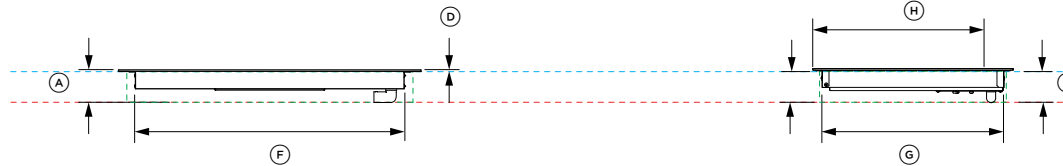

FRONT VIEW

SIDE VIEW

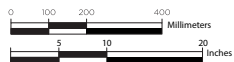

Model no:

CI304ZDTB5

Product Dimensions

	in	mm
(A) Overall height of product (includes glass)	3 9/16	90
(B) Overall width of product	29 15/16	760
(C) Overall depth of product	20 7/8	530
(D) Glass height	5/32	4
(E) Chassis height (excluding glass)	3 3/8	86
(F) Chassis width	28 5/32	715
(G) Chassis depth	19 1/8	485
(H) Distance from front of cooktop glass to conduit	17 1/2	445

Cutout Dimensions

	in	mm
(I) Minimum width	28 3/8	720
(J) Minimum depth	19 5/16	490
(K) Minimum height*	3 9/16	90

Minimum Clearances

	in	mm
Sides of cutout to combustible material	1 3/16	30
Back of cutout to combustible surface	1 9/16	39
Front of cutout to counter edge	1 3/8	35
Cooktop to overhead rangehood or cabinetry	25 19/32	650
Appliances or cabinetry below countertop*	3 9/16	90
Maximum depth of cabinetry over cooktop	13	330
Maximum width of cabinetry over cooktop	29 15/16	760

Weight

Packaged	29 lb	13 kg
Unpackaged	24 lb	11 kg

*Check the ventilation and clearances on page 17 for cutout height options

NOTE: Ventilation is required for cooktops

INDICATES CABINERY / PRODUCT DATUM -----
 INDICATES CABINERY CLEARANCES - - - - -
 INDICATES CUTOUT - - - - -

IMPORTANT NOTE: Throughout this guide, dimensions may vary by ±2mm (1/16"). Please read the installation manual for detailed information on installing the product. For full installation instructions & specifications visit fisherpaykel.com

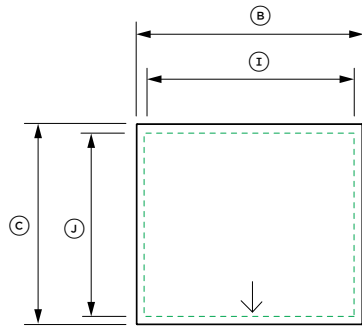

PLAN VIEW

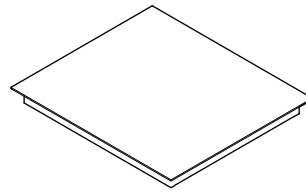

ISOMETRIC VIEW

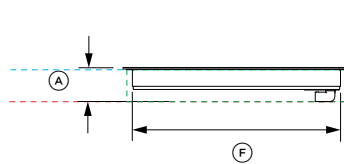

FRONT VIEW

DATUM: BENCHTOP

CLEARANCE: BELOW COOKTOP

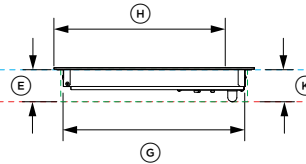

SIDE VIEW

Model no:

CI244ZZDTB5

Product Dimensions

	in	mm
(A) Overall height of product (includes glass)	3 9/16	90
(B) Overall width of product	23 5/8	600
(C) Overall depth of product	20 7/8	530
(D) Glass height	5/32	4
(E) Chassis height (excluding glass)	3 3/8	86
(F) Chassis width	21 7/8	555
(G) Chassis depth	19 1/8	485
(H) Distance from front of cooktop glass to conduit	17 1/2	445

Cutout Dimensions

	in	mm
(I) Minimum width	22 1/16	560
(J) Minimum depth	19 5/16	490
(K) Minimum height*	3 9/16	90

Minimum Clearances

	in	mm
Sides of cutout to combustible material	1 3/16	30
Back of cutout to combustible surface	1 9/16	39
Front of cutout to counter edge	1 3/8	35
Cooktop to overhead rangehood or cabinetry	25 19/32	650
Appliances or cabinetry below countertop*	3 9/16	90
Maximum depth of cabinetry over cooktop	13	330
Maximum width of cabinetry over cooktop	23 5/8	600

Weight

Packaged	22 lb	10 kg
Unpackaged	19 lb	8.5 kg

*Check the ventilation and clearances on page 17 for cutout height options

NOTE: Ventilation is required for cooktops

INDICATES CABINERY / PRODUCT DATUM -----
 INDICATES CABINERY CLEARANCES - - - - -
 INDICATES CUTOUT - - - - -

IMPORTANT NOTE: Throughout this guide, dimensions may vary by ±2mm (1/16"). Please read the installation manual for detailed information on installing the product. For full installation instructions & specifications visit fisherpaykel.com

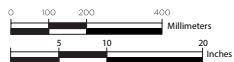

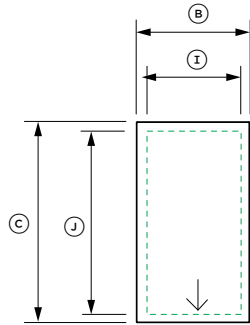

PLAN VIEW

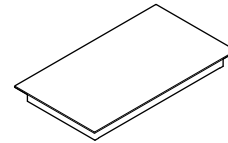

ISOMETRIC VIEW

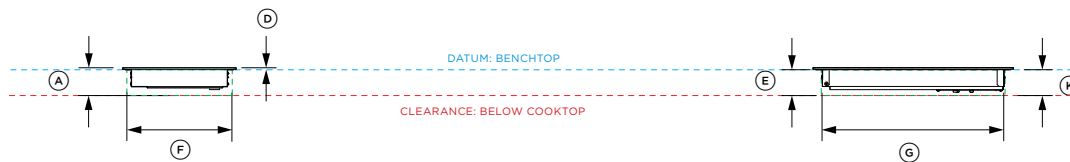

FRONT VIEW

SIDE VIEW

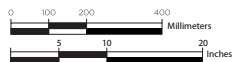

Model no:

CI122ZDTB5

Product Dimensions

	in	mm
(A) Overall height of product (includes glass)	2 7/16	61
(B) Overall width of product	11 13/16	300
(C) Overall depth of product	20 7/8	530
(D) Glass height	5/32	4
(E) Chassis height (excluding glass)	3 3/8	86
(F) Chassis width	10 1/4	260
(G) Chassis depth	19 1/8	485

Cutout Dimensions

	in	mm
(H) Minimum width	10 7/16	265
(I) Minimum depth	19 5/16	490
(J) Minimum height*	2 11/16	68

Minimum Clearances

	in	mm
Sides of cutout to combustible material	1 3/16	30
Back of cutout to combustible surface	1 9/16	39
Front of cutout to counter edge	1 3/8	35
Cooktop to overhead rangehood or cabinetry	25 19/32	650
Appliances or cabinetry below countertop*	2 11/16	68
Maximum depth of cabinetry over cooktop	13	330
Maximum width of cabinetry over cooktop	11 13/16	300

Weight

Packaged	12 lb	5.5 kg
Unpackaged	10 lb	4.5 kg

*Check the ventilation and clearances on page 17 for cutout height options

NOTE: Ventilation is required for cooktops

INDICATES CABINERY / PRODUCT DATUM -----
 INDICATES CABINERY CLEARANCES - - - - -
 INDICATES CUTOUT - - - - -

IMPORTANT NOTE: Throughout this guide, dimensions may vary by ±2mm (1/16"). Please read the installation manual for detailed information on installing the product. For full installation instructions & specifications visit fisherpaykel.com

PLANNING CONSIDERATIONS

3/4" minimum benchtop height for function of retention clips

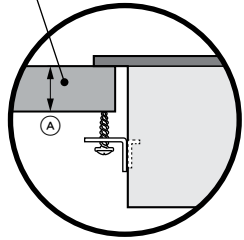

DETAIL - FRONT VIEW
BENCHTOP WITH COOKTOP

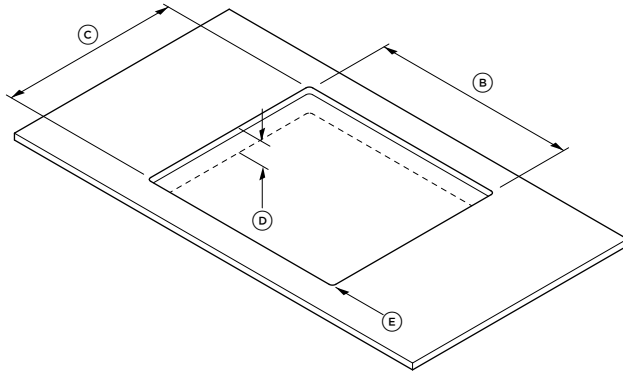

ISO VIEW
BENCHTOP WITH CUTOUT
FOR PROUD INSTALL

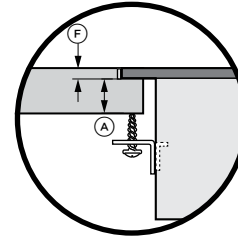

DETAIL - FRONT VIEW
BENCHTOP WITH COOKTOP

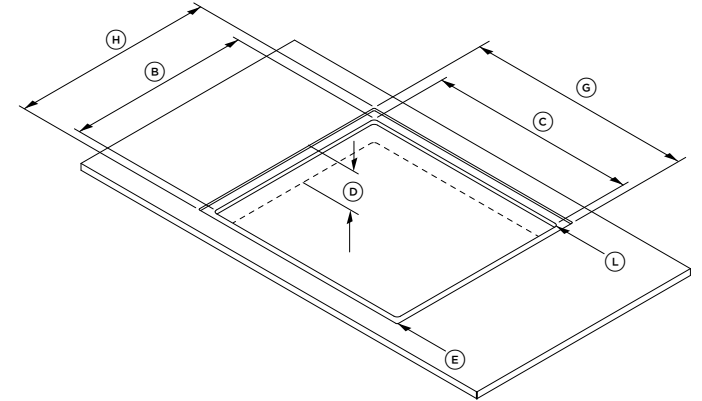

ISO VIEW
BENCHTOP WITH CUTOUT
FOR FLUSH INSTALL

BENCHTOP CHASSIS CUTOUT DIMENSIONS

Cutout Dimensions - Proud	CI122ZDTB5		CI244ZZDTB5		CI304ZDTB5		CI365ZZDTB5	
	in	mm	in	mm	in	mm	in	mm
Ⓐ Minimum thickness	3/4	19	3/4	19	3/4	19	3/4	19
Ⓑ Width of cutout	10 7/16	265	22 1/16	560	28 3/8	720	33 1/2	850
Ⓒ Depth of cutout	19 5/16	490	19 5/16	490	19 5/16	490	19 5/16	490
Ⓓ Minimum height of cavity	2 11/16	68	3 9/16	90	3 9/16	90	3 9/16	90
Ⓔ Maximum corner radius of cutout	3/8	10	3/8	10	3/8	10	3/8	10

ROUTED RECESS DIMENSIONS FOR FLUSH INSTALL

Cutout Dimensions - Flush	CI122ZDTB5		CI244ZZDTB5		CI304ZDTB5		CI365ZZDTB5	
	in	mm	in	mm	in	mm	in	mm
Ⓕ Height of routed recess	1/4	6.5	1/4	6.5	1/4	6.5	1/4	6.5
Ⓖ Width of routed recess	12	305	23 13/16	605	30 1/8	765	35 5/8	905
Ⓗ Depth of routed recess	21 1/16	535	21 1/16	535	21 1/16	535	21 1/16	535
Ⓘ Maximum corner radius of recess	5/32	4	5/32	4	5/32	4	5/32	4

The models shown in this Planning Guide may not be available in all markets and are subject to change at any time. Product specifications may vary from those shown. This Planning Guide should not be used as installation guidance for any product. Further information is required to safely and correctly install the products featured here. Specific installation guidance will be available with the product on delivery and on our website fisherpaykel.com

90MM CLEARANCE: CONDUIT ABOVE A SURFACE

If the cooktop conduit is placed directly over an object or surface, there must be a clearance of 90mm between the countertop and the surface below.

If the surface below is an appliance, ensure the clearance and ventilation requirements for that appliance are met.

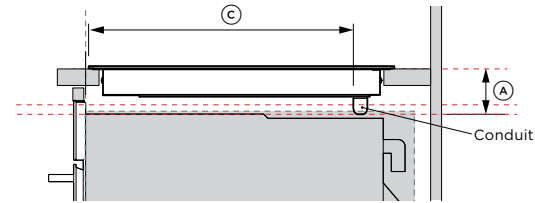

Clearance Dimensions

	in	mm
Ⓐ Product clearance including conduit (all models except CI122ZDTB5)	3 9/16	90
Ⓑ Ventilation only clearance	2 11/16	68
Ⓒ Distance from front of cooktop glass to conduit	17 1/2	445

VENTILATION: FROM REAR OF COOKTOP

Fresh air is drawn up from the toe kick cavity through the rear of the cabinetry.

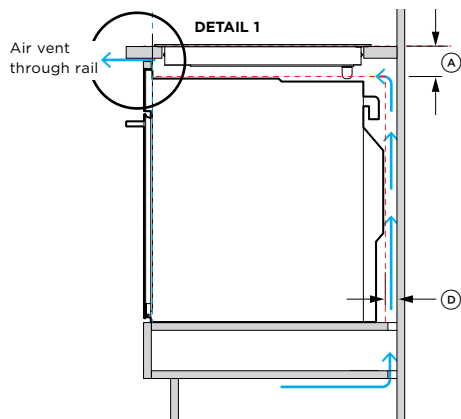

Ventilation Intake Dimensions

	in	mm
Ⓓ Minimum ventilation gap at rear of cabinet*	25/32	20
Ⓔ Diameter of ventilation holes into adjacent cabinets (4x required, 2x on each side of cabinet)*	2	50

*ventilation rear gap or holes required, not both.

68MM CLEARANCE: CONDUIT SET BACK FROM A SURFACE

If the cooktop conduit can be set back from an object or surface below, the clearance can be reduced to 68mm, which allows for ventilation.

If the surface below is an appliance, ensure the clearance and ventilation requirements for that appliance are met.

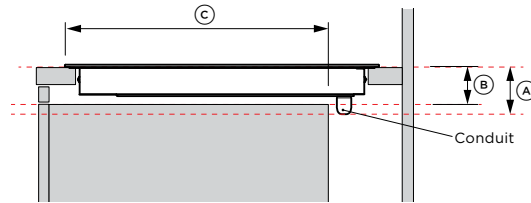

VENTILATION: FROM CABINET SIDES*

If sufficient ventilation at the rear of the cooktop is not possible, add 4x Ø2" holes, two on each side of the cabinet, to allow adequate cooling air.

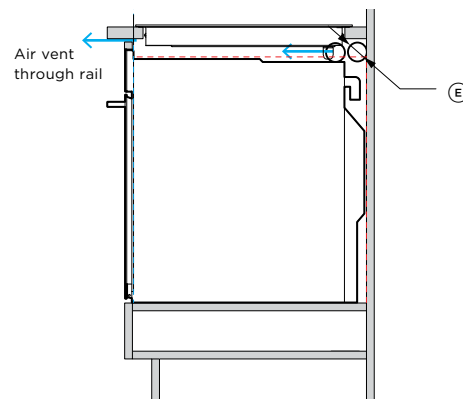

	in	mm
Ⓔ Diameter of ventilation holes into adjacent cabinets (4x required, 2x on each side of cabinet)*	2	50

The models shown in this Planning Guide may not be available in all markets and are subject to change at any time. Product specifications may vary from those shown. This Planning Guide should not be used as installation guidance for any product. Further information is required to safely and correctly install the products featured here. Specific installation guidance will be available with the product on delivery and on our website fisherpaykel.com

VENTILATION DETAILS AT FRONT OF COOKTOP

Hot air must be able to exit at front of cabinets.

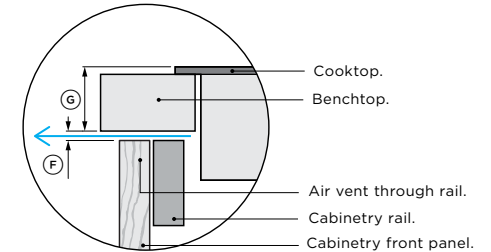

DETAIL 1 - PROFILE VIEW
VENTILATION AT FRONT

Ventilation Dimensions

	in	mm
Ⓕ Ventilation gap at front of cabinet*	5/32	4
Ⓖ Maximum distance of ventilation gap from top of cooktop	1 9/16	40

*gap must run width of chassis

VENTILATION CUTOUT IN CABINETRY RAIL

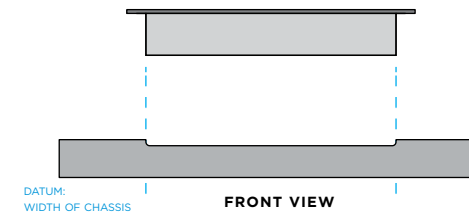

NOTE:
Other rail cutouts are possible but must meet the required ventilation area.

Ventilation Area Required at Front of Cooktop

	w x h in	w x h mm	in ²	cm ²
CI122ZDTB5	10 1/4 x 5/32	260 x 4	1.6	10.4
CI244ZDTB5	21 7/8 x 5/32	555 x 4	3.4	22.2
CI304ZDTB5	28 5/32 x 5/32	715 x 4	4.4	28.6
CI365ZDTB5	33 1/4 x 5/32	845 x 4	5.2	33.8

SERVICES

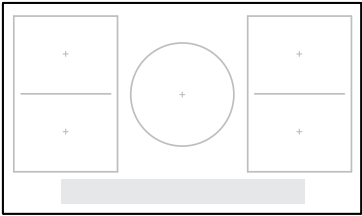

36" 5 ZONE INDUCTION COOKTOP

Model no:
CI365ZZDTB5 Black

Power Requirements	
Rated power (W)	10400
Supply (Hz)	60Hz
Voltage (V)	208 / 240V
Dedicated circuit (A)	USA 40 A Canada 50 A
Connection	Flexible metal conduit, length 48"

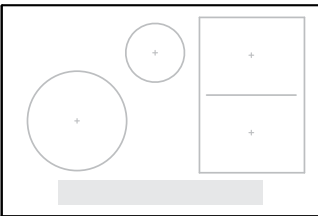

30" 4 ZONE INDUCTION COOKTOP

Model no:
CI304ZDTB5 Black

Power Requirements	
Rated power (W)	7400
Supply (Hz)	60Hz
Voltage (V)	208 / 240V
Dedicated circuit (A)	USA 35 A Canada 40 A
Connection	Flexible metal conduit, length 48"

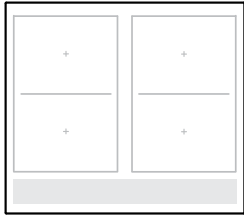

24" 4 ZONE INDUCTION COOKTOP

Model no:
CI244ZZDTB5 Black

Power Requirements	
Rated power (W)	7400
Supply (Hz)	60Hz
Voltage (V)	208 / 240V
Dedicated circuit (A)	USA 35 A Canada 40 A
Connection	Flexible metal conduit, length 48"



12" 2 ZONE INDUCTION COOKTOP

Model no:
CI122ZDTB5 Black

Power Requirements	
Rated power (W)	3700
Supply (Hz)	60Hz
Voltage (V)	208 / 240V
Dedicated circuit (A)	20 A
Connection	Flex cord, length 48"

The models shown in this Planning Guide may not be available in all markets and are subject to change at any time. Product specifications may vary from those shown. This Planning Guide should not be used as installation guidance for any product. Further information is required to safely and correctly install the products featured here. Specific installation guidance will be available with the product on delivery and on our website fisherpaykel.com

