

**FISHER & PAYKEL**

**FABRIC CARE SOLUTIONS  
MULTI-PRODUCT SETUP**

---

FRONT LOADER WASHER

WH1260YZB5

DISPLAY-FREE HEAT PUMP DRYER

DH1060YLZB5

**USER GUIDE**

**NZ AU**



## CONTENTS

---

Safety and warnings	4
Get to know your washer and dryer	10
Control panel	12
Menu	13
Understanding fibre types	14
Get the best results from your dryer	15
Prime and check washer	16
Detergent cartridges	17
Set detergent types	18
Sort your items	19
Load the washer and dryer	20
Set a wash cycle	22
More wash options	26
Set a dry cycle	28
Fit drying rack	31
More dry options	32
Set delayed start	33
Save favourite cycles	34
Adjust settings	36
Wi-Fi connection and remote mode	38
Cycle selections	41
Wash treatments	49
Choose a detergent	52
Clean and maintain your washer and dryer	53
Clean the washer dispenser drawer	55
Run the washer Drum Clean cycle	56
Unlock the washer door	57
Clean the washer pump filter	58
Clean the dryer lint filters	60
Troubleshooting	62
Faults	69
Compliance information	70
Manufacturer's Warranty and Service Guide	72

---

### Registration

To register your product visit our website: [fisherpaykel.com/register](http://fisherpaykel.com/register)

## SAFETY AND WARNINGS

### ⚠ WARNING!



#### **Electric Shock Hazard**

Failure to follow this advice may result in electric shock or death.

- If you are using an extension cord or a portable electrical outlet device (eg multi-socket outlet box), ensure that it is positioned so that it does not come into contact with water or moisture.

### ⚠ WARNING!



#### **Fire Hazard**

- Only dry fabrics that have been washed with water.
- Do not use heat to dry articles containing foam rubber or similarly textured rubber-like materials.
- Never stop a tumble clothes dryer before the end of the drying cycle unless all items are removed and spread out in order to dissipate the heat.
- A clothes dryer produces combustible lint; the lint filter must be cleaned before each drying cycle.
- Failure to follow the warnings outlined in these user instructions can cause a fire hazard.
- Failure to follow these instructions can result in death or personal injury.

### ⚠ WARNING!



**R290**

**This appliance contains flammable refrigerant isobutane (R290).**

## SAFETY AND WARNINGS

### ⚠ WARNING!



#### Keep detergents out of reach of children

- Detergents can be hazardous. Keep cartridges out of reach of children.
- Store detergents and softeners as per manufacturers' recommendations.



#### Read the instructions

### WARNING!

**Read Safety Guide. Failure to follow all guides and rules could cause personal injury or property damage. Use this appliance only for the intended purpose as described in the user guide and installation guide of this appliance. When using this appliance, always exercise basic safety precautions including the following:**

## WASHER

### General

- This product has been designed for personal, family or household use. This product is not designed for any commercial use.
- Do not touch or operate the appliance with wet hands or with bare feet.
- A damaged power cord must be replaced by a Fisher & Paykel trained and supported service technician or similarly qualified person in order to avoid a hazard. Do not use the machine until it has been repaired to avoid a risk of electric shock.
- Do not operate this appliance if it has been damaged during transport. Contact your Fisher & Paykel dealer or Fisher & Paykel trained and supported service technician.
- This appliance is not intended for use by persons (including children) with reduced physical, sensory or mental capabilities, or lack of experience and knowledge, unless they are supervised or given instructions on how to use the appliance by someone responsible for their safety.
- Never place dripping wet clothes on top of the washer as this could create an electrical hazard.
- Keep children away from the washing machine while it is in operation.
- Supervise children to ensure they do not play with the appliance or climb inside the drum.
- Do not swing on or put weight on the door.
- Check and remove all objects from pockets, e.g. lighters and matches.
- The washing machine should only be used for washing and rinsing of textiles where this is indicated on the care label.
- Do not add petrol, dry-cleaning solvents, or other flammable or explosive substances to the wash water. These substances give off vapours that could ignite or explode.
- Do not wash articles that have been previously cleaned in, washed in, soaked in, or spotted with gasoline, dry-cleaning solvents, or other flammable or explosive substances as they give off vapours that could ignite or explode.

## SAFETY AND WARNINGS

---

- The door will be locked from the start of the cycle until the cycle is complete for safety reasons. It is possible to open the door during the cycle under certain conditions. Never force the door open.
- Do not touch the door during a cycle as the door can become hot.
- When Sanitise and Allergy cycles are selected, the door glass will become hot. Do not touch the glass part of the door. Keep children away from the washing machine.
- Do not open the detergent dispenser during the cycle as hot water may come out of it.
- Read and follow the detergent manufacturer's instructions carefully. Instructions on how to use the detergent will be clearly indicated on the pack. Remember to store your detergents out of the reach of children.
- Do not wash an electric blanket in your washing machine unless the care label specifically states it is safe to do so.
- Do not wash curtains in this washing machine, as sunlight makes them brittle and they may disintegrate during washing.
- Do not put dripping wet clothes on top of the washer as this could create an electrical hazard.
- The only user-removable parts of the washing machine are the inlet hose(s), dispenser drawer, pump filters and cartridges. No other parts are designed to be removed by anyone other than a Fisher & Paykel trained and supported service technician.
- Do not overload your washing machine beyond its rated capacity.

---

<b>MODEL CODE</b>	<b>MAXIMUM CAPACITY* (KG)</b>
WH1260YZB5	12kg

---

\*Capacity refers to the maximum dry weight of items the washing machine can wash at any one time

### Installation

- Install the appliance on a solid and level floor surface. Ensure it has at least 12mm clearance on each side and at the top, and at least 30mm clearance at the rear.
- The appliance must not be installed on any textured floor coverings (e.g. carpet, rugs).
- This appliance can be installed on a compatible Fisher & Paykel plinth or washer with a stacking kit. To ensure stability, the plinth or stacking kit must be fitted correctly with the appliance. For installation instructions and compatible plinth models, refer to [fisherpaykel.com](http://fisherpaykel.com).
- Do not install or operate this appliance on any other plinth or structure.
- Ensure the installation provides accessibility to the plug or incorporate a switch in the fixed wiring in accordance with the wiring rules to allow disconnection of the appliance from the supply after installation.
- Do not attempt to lift washer on your own as this could cause harm or injury. Always lift appliance with at least two people.
- Do not operate this machine if it has been damaged during transport. Contact your Fisher & Paykel dealer or Fisher & Paykel trained and supported service technician.
- Ensure any transit bolts have been removed before operating appliance.

### Water supply requirements:

- Inlet water pressure: Max. 1MPa (145psi), Min. 50kPa (7.3psi)
- Inlet water flow rate: Min. 6 litres/minute
- A pressure-reducing valve must be installed if pressure is higher than 1MPa.
- For optimum wash performance check the supply pressure is within the recommended range.
- New hose sets provided should be used to connect the appliance to the water mains. Old hose

## SAFETY AND WARNINGS

---

sets should not be re-used.

- We recommend the inlet hose(s) are changed every 5 years. **WARNING:** Failure to do so may result in a flood and damage to property.
- The hot water temperature should not exceed 65°C and the cold water temperature should not exceed 35°C. Temperatures above these may cause the appliance to fault or cause damage to it.

### Disposal

- When disposing of this appliance, the door should be removed to avoid children getting trapped inside, and that the electrical cable is cut off close to the cabinet.

## DRYER

- Do not touch or operate the appliance with wet hands or with bare feet.
- A damaged power cord must be replaced by a Fisher & Paykel trained and supported service technician or similarly qualified person in order to avoid a hazard. Do not use the machine until it has been repaired to avoid a risk of electric shock.
- Do not operate this appliance if it has been damaged during transport. Contact your Fisher & Paykel dealer or Fisher & Paykel trained and supported service technician.
- This product has been designed for personal, family or household use. This product is not designed for any commercial use. Any commercial use will terminate this products manufacturer's warranty.
- This appliance is not intended for use by persons (including children) with reduced physical, sensory or mental capabilities, or lack of experience and knowledge, unless they are supervised or given instructions on how to use the appliance by someone responsible for their safety.
- Supervise children to ensure they do not play with the appliance or climb inside the drum.
- Do not swing on or put weight on the door.
- Undergarments that contain metal reinforcements should not be placed in the dryer. Damage to the dryer can result if the metal reinforcements come loose during drying. If you wish to dry these items use a drying rack or place in a garment bag.
- Check and remove all objects from pockets, eg lighters and matches.
- Items should go through the cooling phase in the final part of the cycle. This ensures items are left at a temperature where they will not be damaged. If for any reason the cycle is stopped before it has finished, dry clothes should be removed immediately and not left in the appliance. Items should be quickly spread out flat to cool so heat can dissipate, not left bunched up, eg in a clothes basket or in a pile.
- In the event of a power outage the cycle will be paused when power is restored. Press Confirm, then Start/Pause to resume the cycle.
- The only user-removable parts of the dryer are the filters and drying rack. No other parts are designed to be removed by anyone other than a Fisher & Paykel trained and supported service technician.
- For problems that cannot be solved from information in the user guide, turn off and unplug your appliance and contact a Fisher & Paykel trained and supported service technician.
- Never attempt to repair the appliance yourself.
- Do not put dripping wet clothes in or on top of the dryer as excess water may cause an electrical hazard.
- Do not under any circumstances place an electric blanket or any other electrical, plastic or rubber items in the appliance, unless the care label specifically states it is safe to do so.
- A module may separate from its housing (located at the top-right of the door opening) upon removal of the tape used to secure it for transport. Dislodging of the module might sometimes occur in use. If so, return it to its housing, ensuring it snaps back into place securely.

## SAFETY AND WARNINGS

---

- Do not overload your dryer beyond its rated capacity.

MODEL	MAXIMUM CAPACITY* (KG)
DH1060YLB5	10

\*Capacity refers to the maximum dry weight of items the dryer can dry at any one time

- Do not dry curtains in your dryer.
- This model does not have a water tank. The drain hose must be connected before operating. Do not run the dryer without the drain hose connected.

### Lint

- Do not operate this appliance without the lint filters in place, or allow lint to accumulate in or around the appliance.
- Accumulated lint in the appliance can become a fire hazard; it also reduces the efficiency of the appliance by causing longer drying times and increased power consumption.
- Clean the lint filter before every load.
- Ensure the area around the appliance is clear of lint.
- If the lint filter becomes damaged, contact your Fisher & Paykel trained and supported service technician to arrange getting a new filter. Do not operate your appliance with a damaged lint filter or without the filter in place, as this will cause damage to your appliance.

### Spontaneous combustion

To reduce the risk of fire the following should be observed:

- Items that have been spotted or soaked with vegetable oil or cooking oil are a fire hazard and should not be placed in the appliance.
- Oil-affected items can ignite spontaneously, especially when exposed to heat sources such as this appliance. The items become warm causing an oxidation reaction in the oil. This oxidation creates heat. If the heat cannot escape the items can become hot enough to catch fire. Piling, stacking or storing oil-affected items can prevent heat from escaping creating a fire hazard.
- If it is unavoidable that fabrics that contain vegetable oil, cooking oil or have been contaminated by hair care products be placed in this appliance, they should first be washed in hot water with extra detergent – this will reduce, but not eliminate the fire hazard. The cooling cycle should be used to reduce the temperature of these items. They should not be removed from the appliance and piled or stacked while hot.
- Items that have previously been cleaned in, washed in, soaked in or spotted with flammable liquids or solids, eg petrol/gasoline, kerosene, dry cleaning solvents, vegetable or cooking oil, acetone, denatured alcohol, some brands of spot removers, turpentine, waxes and wax removers or other flammable or explosive substances should not be placed in the appliance.
- The appliance is not to be used if industrial chemicals have been used for cleaning.
- Fabric softeners or similar products should not be used in the appliance to eliminate the effects of static electricity, unless this practice is specifically recommended by the manufacturer of the fabric softener product.
- Items such as foam rubber (latex foam), shower caps, rubber backed articles, clothes or pillows fitted with foam rubber pads, waterproof textiles, shoes containing rubber or plastic items should not be placed in the appliance. These materials can spontaneously combust when heated.

## **SAFETY AND WARNINGS**

---

- Do not dry unwashed items in the appliance.
- When using **REFRESH** cycles on unwashed clothing ensure there are no flammable substances on them.

### **Installation**

- This appliance is heavy. We recommend two persons to move and install the appliance.
- The appliance must not be supplied through an external switching device, such as a timer, or connected to a circuit that is regularly switched on and off by a utility.
- We do not recommend the use of extension cords or portable electrical outlet devices for safety reasons.
- Install the appliance on a solid and level floor surface.
- The appliance must be installed in a well-ventilated, dust-free environment.
- The appliance must not be installed on any textured floor coverings (eg carpet, rugs). Ensure that openings at the base of the appliance are not obstructed.
- The appliance must not be installed behind a lockable door, a sliding door or a door with the hinge on the opposite side to that of the tumble dryer, in such a way that a full opening of the tumble dryer door is restricted.
- If installing behind a cabinetry door, it must be hinged on the same side as the dryer and there must be a minimum clearance of 40mm from the front of the dryer door to the internal face of the cabinetry door for the product to operate safely. The enclosed space must be provided with sufficient ventilation to meet local building code requirements or the door must be open while the product is operating.
- This appliance can be installed on a compatible Fisher & Paykel plinth. To ensure stability, the plinth must be fitted correctly with the appliance. For installation instructions and compatible plinth models, refer to [fisherpaykel.com](http://fisherpaykel.com).
- Do not install or operate this appliance on any other plinth or structure.
- For more information refer to the installation guide. To access, go to [fisherpaykel.com/](http://fisherpaykel.com/) specify and search by appliance type, product name or model.

### **Water supply requirements**

- Inlet water pressure: Max. 1MPa (145psi), Min. 30kPa (4.5psi)
- Inlet water flow rate: Min. 6 litres/minute
- The cold water temperature should not exceed 35°C. Temperatures above these may cause the appliance to fault or cause damage to it.
- A pressure-reducing valve must be installed if pressure is higher than 1Mpa.
- New hose sets provided should be used to connect the appliance to the water mains. Old hose sets should not be re-used.
- We recommend the inlet hose(s) are changed every 5 years. **WARNING:** Failure to do so may result in a flood and damage to property.

### **Disposal**

- When disposing of this appliance, it is recommended that the door is removed to avoid children getting trapped inside and that the electrical cable is cut off close to the dryer.

## GET TO KNOW YOUR WASHER AND DRYER



Download the app for a smarter experience

- Access extra features and information
- Get the latest software updates
- Track and run cycles from your phone
- Customise your favourite cycles
- Register your products for streamlined support



### WASHER FEATURES AND ACCESSORIES

- |   |  |   |                          |
|---|--|---|--------------------------|
| 1 | Touchscreen display                                    | 5 | Pump drain hose          |
| 2 | Power button   | 6 | Pump filter              |
| 3 | Detergent/Softener dispenser drawer                    | 7 | Drum light (inside drum) |
| 4 | Manual door-release tab (for use during power failure) |   | Dispenser cartridges (6) |

## GET TO KNOW YOUR WASHER AND DRYER

---

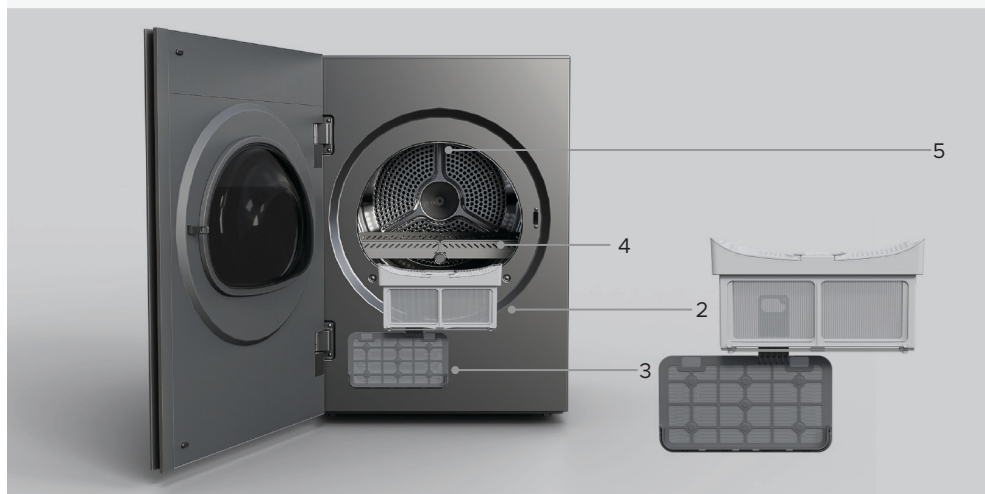
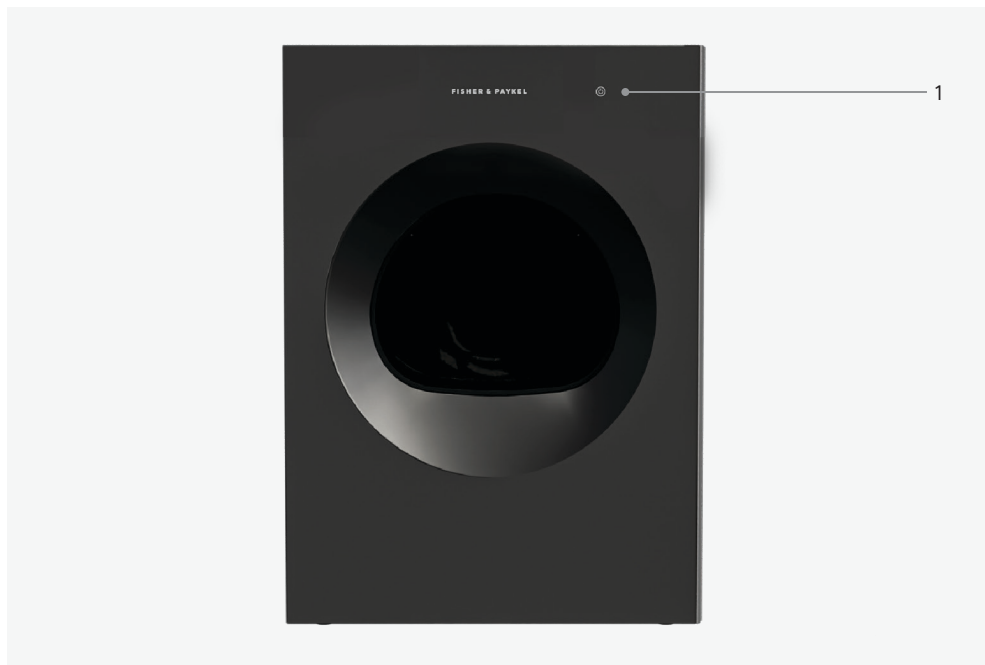

---

### DRYER FEATURES AND ACCESSORIES

---

- |   |                                       |   |                          |
|---|---------------------------------------|---|--------------------------|
| 1 | Power button                          | 4 | Drying rack              |
| 2 | Lint filter                           | 5 | Drum light (inside drum) |
| 3 | Lower lint filter (under lint filter) |   |                          |



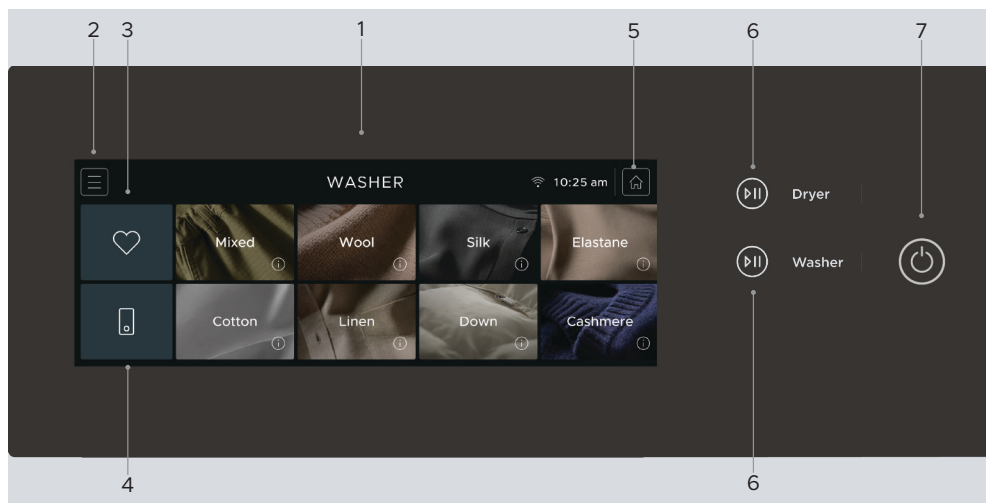



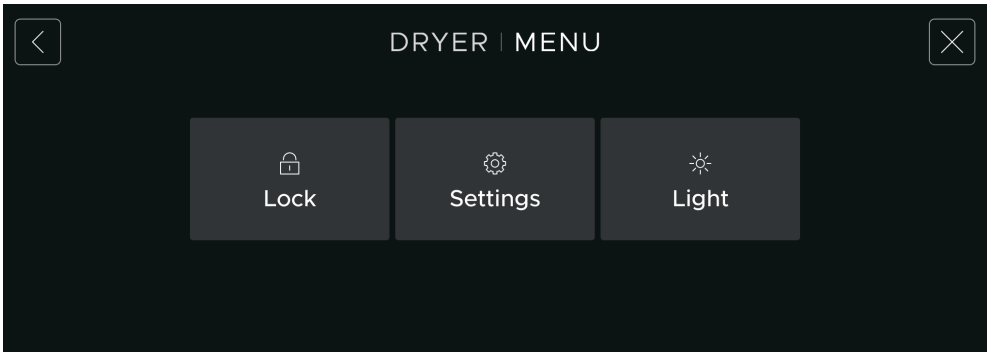
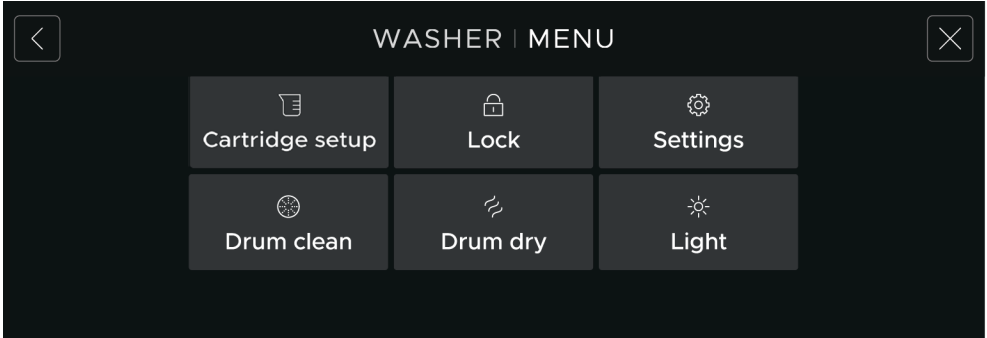

## CONTROL PANEL



1	Touchscreen display	Use to navigate and select cycles, features and settings. WASHER or DRYER will display to show which controls are active.
2	Menu	Press MENU  to access additional features and settings. Washer menu will display when selected from WASHER screen. Dryer menu will display when selected from DRYER screen.
3	Favourites	Press FAVOURITES  to access saved favourite and preset cycles. You can save before, during or at the end of a cycle.
4	Remote	Press REMOTE  to connect appliance to your mobile device and operate it via the app.
5	Home	Press HOME  to return to home screen and switch between washer and dryer controls.
6	Start/Pause	Press to start or pause a cycle or enable Remote mode for washer or dryer. WASHER and DRYER will light up when an appliance is in use.
7	Power	Press and hold to turn the appliance ON/OFF.

## MENU



	<b>CARTRIDGE SETUP</b>	Set or adjust detergent and softener cartridges and dosage. See 'Set detergent types'.
	<b>LOCK</b>	Lock the controls at any time to prevent accidental use. Locks screen for washer and dryer.
	<b>LIGHT</b>	Turn the drum light off or set it to turn on automatically.
	<b>DRUM CLEAN</b>	Run DRUM CLEAN to clean the washer.
	<b>DRUM DRY</b>	Run DRUM DRY or set it to run after a wash cycle by default.
	<b>SETTINGS</b>	Set and adjust clock, display, volume and other settings to suit your preferences. See 'Adjust settings'.
	<b>BACK</b>	Go back one level.
	<b>EXIT</b>	Return to the home screen.

## UNDERSTANDING FIBRE TYPES

### Every cycle starts with fibre type

Each fibre type responds differently to washing and drying. This appliance uses a fibre-led system and precision sensing to wash your items, so selecting the right fibre type for each load is key to setting the best cycle each time.

### Treat for the most delicate fibre

Items may be a blend of multiple fibres — some more delicate than others. The care label on an item will tell you what fibre or fibres the item is made of and how to care for it.

Select the fibre type on your washer that applies to the most sensitive or delicate fibre in the blend, even if it is only a small percentage.

### Identify delicate fibres

This table helps identify the most delicate or sensitive fibres commonly found on care labels. It also offers alternative cycle suggestions for specialist fibres. Recommendations may not suit all items — always check your care label first.

For best results, use a detergent designed for the most delicate fibre. See ‘Choose a detergent’ for more information.

SENSITIVITY	COMMON FIBRES	FIBRE TYPE
 High	Cashmere, Angora, Mohair	Cashmere
	Down	Down
	Silk	Silk
	Wool, Merino, Lambswool	Wool
	Elastane, Spandex, Lycra	Elastane
	Viscose, Bamboo, Rayon, Modal	Viscose
	Lyocell, Tencel™	Lyocell
	Acrylic	Acrylic
	Linen	Linen
	Hemp	Hemp
	Ramie	Ramie
	Nylon, Polyamide	Nylon
	Polyester	Polyester, Mixed
Low	Cotton	Cotton, Mixed

## GET THE BEST RESULTS FROM YOUR DRYER

---

### Heat pump versus vented dryer

Your heat pump dryer is different to a traditional vented dryer. Heat pump technology dries your items at a lower temperature than a vented dryer to ensure gentle, energy-efficient fabric care without overdrying your items.

### Get to know your dryer

Take the time to become familiar with cycle selections and how they suit your items. Save your favourite cycles for quick and easy access on the product or in the app, and clean and maintain your dryer to keep it performing at its best.

---



### Recognising post-dryer feel

Items may feel slightly damp when first removed from a heat pump dryer, but they will feel completely dry within a few minutes and are ready to wear immediately. If you prefer your items to feel completely dry as soon as the drying cycle ends, you can adjust the dryness level. See 'Select Dryness'.

---

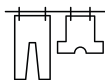

### Finishing air-dried items in the dryer

Use a TIME DRY cycle for at least 30 minutes to finish partially dry items. This allows time for the dryer to reach temperature.

---



### Loading items directly from the washing machine

Make sure items have been through a spin cycle to remove excess water before placing them in the dryer. Overly wet items will extend the drying cycle and may affect drying performance.

---

## PRIME AND CHECK WASHER

Before you wash your first load, we recommend running a QUICK 15 cycle to prime the detergent dispenser. During the cycle, check that the hoses are connected properly and the washer is sitting level.



1. Push the dispenser drawer to open it. Fill cartridge 1 with everyday detergent, then close the drawer.

You can also fill and insert the softener cartridge if you intend to use softener.

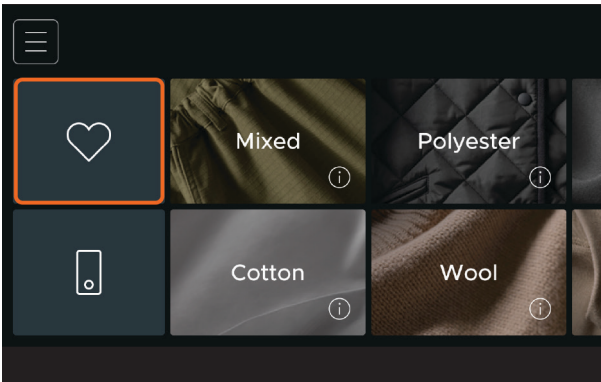

1. Press FAVOURITE  and select QUICK 15.

FAVOURITE  is preset with QUICK 15 and QUICK 30 cycles. See 'Save Favourite cycle' for information about adding new favourite cycles.

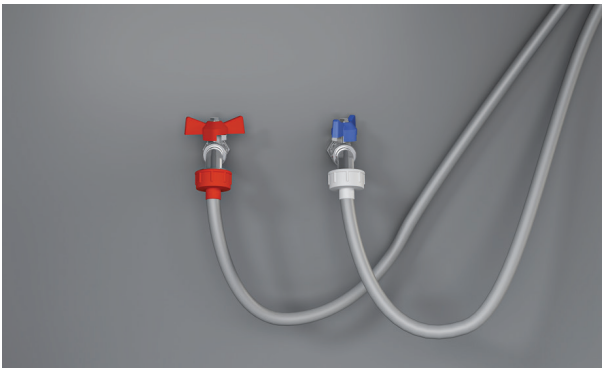

### What to look for

- If the washer is leaking, check the hose connections.
- If the washer is moving around, adjust the feet to level it.

See the 'Installation guide' for instructions.

## DETERGENT CARTRIDGES



Your washer's modular dispenser cartridges make it quick and easy to switch between everyday and specialist detergents for optimal wash performance across every cycle and item.

The washer comes with six cartridges:

- One large and three small auto dose cartridges you can set to dispense everyday or specialist detergents.
- One auto dose liquid softener cartridge.
- One manual dose cartridge for liquid or powder detergent.

Extra cartridges are available to order via the app and [fisherpaykel.com](https://fisherpaykel.com).

---

### Liquid detergent options for unassigned cartridges

---

Everyday	Sensitive	Down	Darks
Delicates	Wool	Silk	Whites

---

The washer will detect cartridges in the dispenser and prompt you to set up any that are not set. When setting up your cycle, the washer will also prompt you to insert a cartridge with the recommended detergent for that cycle if one is not already inserted.

You can set or change detergent types and dose levels in **Cartridge Setup** or temporarily adjust dose level for a specific wash cycle.

See 'Set detergent types' for how to set detergent types to cartridges and adjust dosages.

### Filling the cartridge

Fill auto dose cartridges to the underside of the lid. Each fill lasts for multiple cycles, and a reminder will display when the cartridges need to be refilled. When not in the dispenser drawer, store full cartridges level and out of reach of children.

See 'Choose a detergent' for information about different detergent types.

### Manual dispensing

MANUAL dispenses all the detergent in the Manual cartridge. Only add as much detergent to the Manual cartridge as you need for that load.

If using a detergent pod, set the dispenser to MANUAL. Add the pod directly to the washer drum and put your items on top of the pod.

See 'Set a cycle' for how to select manual dispensing.

## SET DETERGENT TYPES

Use **Cartridge setup** to assign detergent types to cartridges so you can easily switch between everyday and specialised detergents. The washer will detect which cartridges are in the dispenser drawer.

The **DEFAULT** dose setting automatically dispenses the appropriate dose of detergent and softener during each cycle, but you can adjust dosage levels to suit your needs.

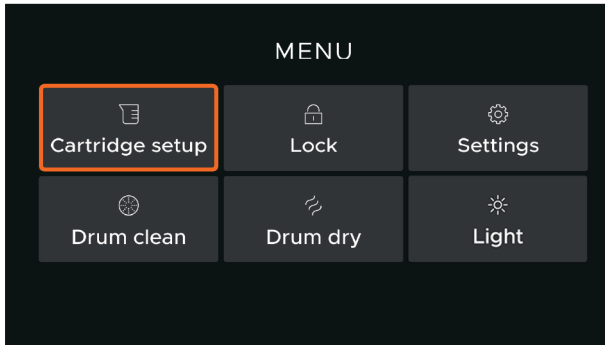

1. Go to MENU  and select **CARTRIDGE SETUP**, then follow the onscreen prompts.



2. Scroll to select a detergent type and dose, then press **CONFIRM**.

Press **UPDATE** to change the detergent type and dose for a cartridge.

Press **RESET CARTRIDGE** to clear all settings.

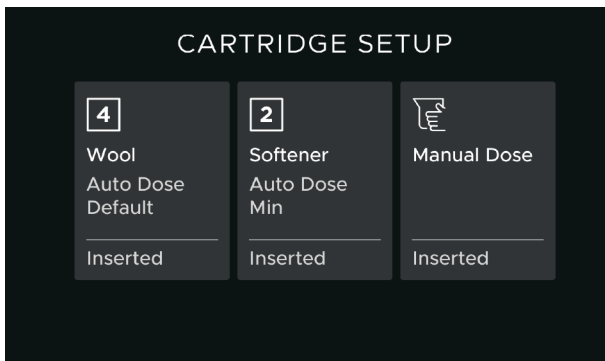

3. The list of inserted cartridges will show on the screen.

Press **ALL CARTRIDGES** to see the list of cartridges you have set up.

## SORT YOUR ITEMS

---

Sorting your items well is essential for taking care of your clothes and getting the best results from your appliance. Follow these steps every time you use the washer or dryer.



1. Check each care label to see the fibre composition and how each garment should be cared for. See 'Understanding fibre types.'



2. Sort items into loads of similar fibre, item type and item colour.



3. Check pockets, close fasteners and zippers, and untangle items before loading.

Use a small washbag when washing delicate items, and be careful not to overfill it.

## LOAD THE WASHER AND DRYER

### Maximum load size

The maximum load size changes based on the type of items in a load. Follow the guide below to avoid overfilling the washer or dryer and maintain good performance.



### WASHER

Mixed, Cotton, Polyester	Ultra delicate	Extra small
	Delicate, Denim or Sports	Small
	Moderate, Durable, Sheets, Towels or Bulky	Large
Wool	Ultra delicate or Delicate	Small
Elastane	Ultra delicate	Extra small
	Delicate	Small
	Moderate	Medium
Down, Viscose, Acrylic, Hemp, Lyocell, Ramie	Ultra delicate	Extra small
	Delicate	Small
Silk	Ultra delicate	Extra small
Linen	Ultra delicate	Extra small
	Delicate	Small
	Moderate, Sheets or Towels	Large
Nylon	Ultra delicate	Extra small
	Delicate or Outdoor	Small
Cashmere	Ultra delicate	Extra small
Other Treatments	Favourite - Quick 15	Small
	Favourite - Quick 30	Medium
	Refresh	1 or 2 Items
	UV Sanitise, Hot Sanitise	As per fibre/item type
	Proofing	1 or 2 items
	Stain care	Small

## LOAD THE WASHER AND DRYER

DRYER		
Mixed, Cotton, Polyester	Ultra delicate	Extra small
	Delicate, Outdoors	Small
	Moderate, Durable	Large
	Sheets, Towels, Denim, Sports, Bulky	Medium
	Soft toys	4 toys
	Shoes	2 pairs
Wool	Ultra delicate, Delicate	Extra small
Elastane	Ultra delicate	Extra small
	Delicate	Small
	Moderate	Medium
Down	Ultra delicate	Extra small
	Delicate	Small
	Bulky	Medium
	Quilts & duvets	1 item
Silk	Ultra delicate	Extra small
Linen	Ultra delicate	Extra small
	Delicate	Small
	Moderate, Sheets or Towels	Medium
Nylon	Ultra delicate	Extra small
	Delicate	Small
	Outdoors	Small
Viscose, Acrylic, Hemp, Lyocell, Ramie	Ultra delicate	Extra small
	Delicate	Small
	Moderate	Small
Cashmere	Ultra delicate	Extra small
Other Treatments	Rack dry	1 or 2 items
	Steam refresh	1, 2 or 3 items
	Sanitise dry	Medium
	Allergy care	Medium to large

## SET A WASH CYCLE

Your washer has specialised cycles for specific fibre types. Start by selecting a fibre type, then select an item type based on durability or specific items, such as sheets or towels, and the required treatment. You can adjust settings for soil level, colour and dispensing. The available cycle options may vary depending on the fibre type you select.

### Automatic cycle settings

Cycle settings like temperature and spin speed no longer need to be set manually. These settings will all adjust automatically based on your cycle selections. Press **INFORMATION** ⓘ or see 'Cycle selections' for details about which fibre to choose.

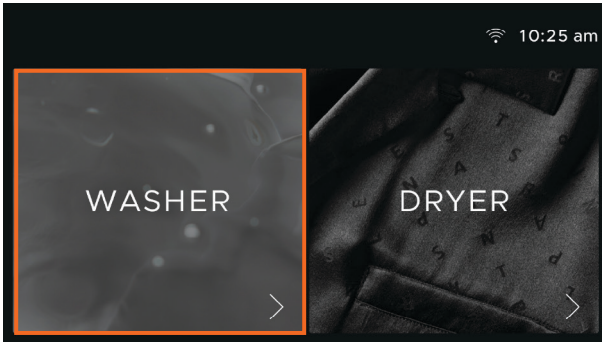

1. Select **WASHER** from the home screen.

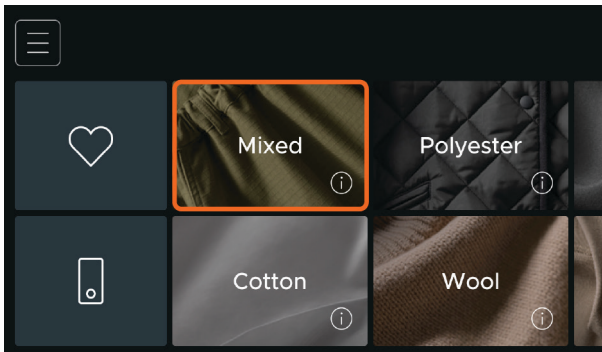

2. Select a fibre type.  
Press **INFORMATION** ⓘ for a description of each fibre.

## SET A WASH CYCLE

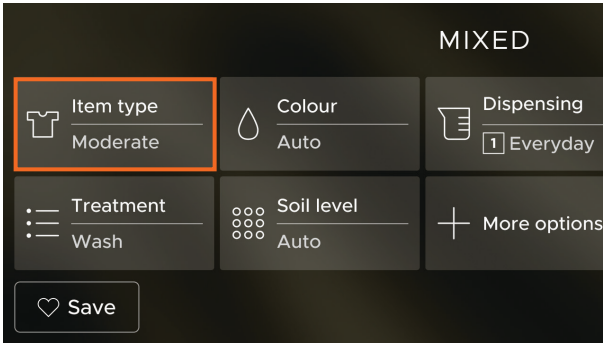

3. Press ITEM TYPE to access the options and see a description and examples for each type. Scroll to select an item type.

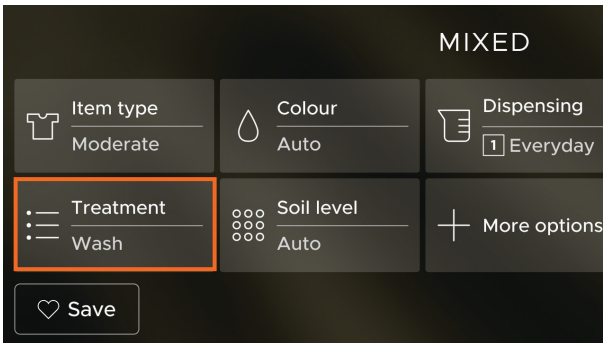

4. Press TREATMENT to access the options and descriptions. Scroll to select a treatment.

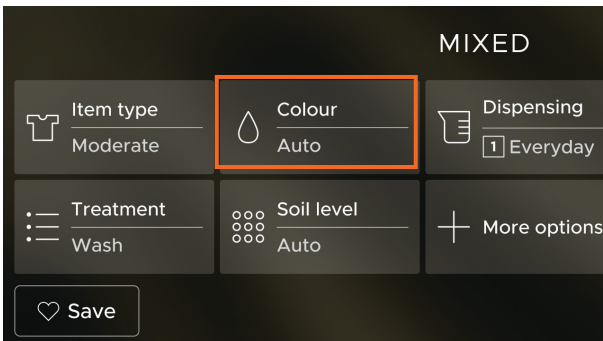

5. Press COLOUR to access the options.

Select a colour option or use AUTO (some models only).

AUTO senses the colours in the load and adjusts the wash temperature to suit.

## SET A WASH CYCLE

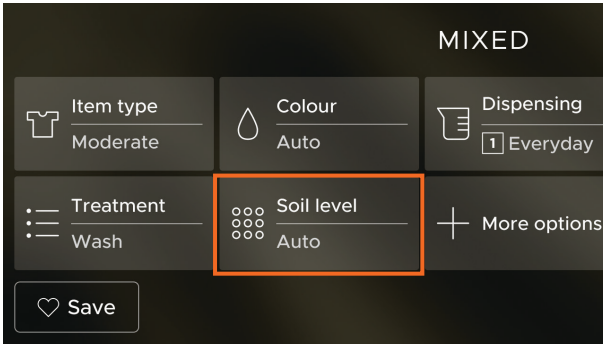

6. Press SOIL LEVEL to select a soil level option, or use AUTO. AUTO senses the soil level and adjusts the wash time and detergent dose to suit.



7. Select a dispensing option for detergent and softener. You can select the Auto Dose tanks or the Manual tank. See 'Add detergent and softener' and 'Set up Auto Dose' for details.

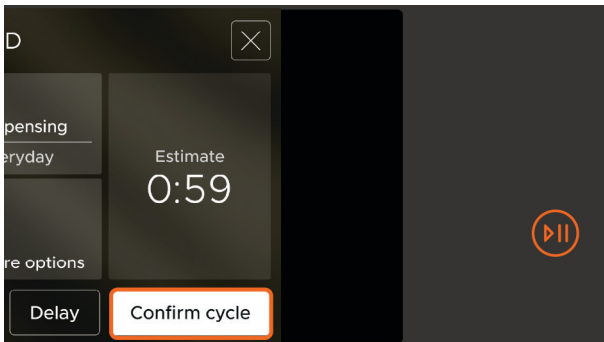

8. Press CONFIRM CYCLE then press the START/PAUSE button to begin the cycle. The cycle progress will show on the display. See 'More options' for details about more wash options. See 'Set Delayed start' for how to schedule your wash to start at a later time.

## SET A WASH CYCLE

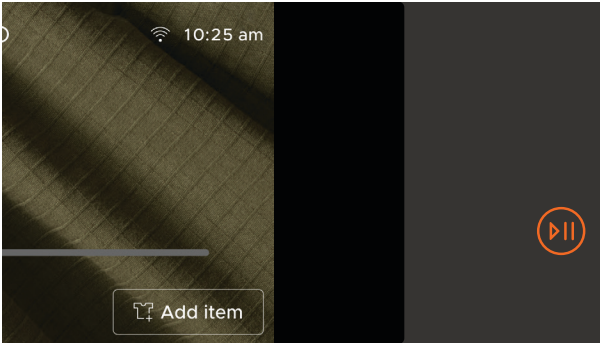

### Pausing the cycle

Press the **START/PAUSE** ▶|| button to pause the cycle.

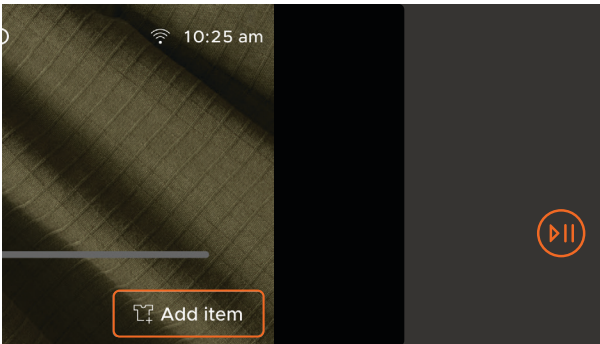

### Add Item

Press **ADD ITEM** to pause the wash and add an item. For best results, add within 10 minutes of starting the cycle. The washer may drain slightly so door can open safely.

Not available on all cycles.

Press **RESUME**, then press the **START/PAUSE** ▶|| button to resume the cycle.



### Cancelling the cycle

Press **CANCEL** and follow the prompts to cancel the cycle.

The door will remain locked until the water level has drained below the door.

## MORE WASH OPTIONS

Optimise	Optimise the cycle as required to save energy, reduce wash time or reduce noise. Select from Balanced, Energy, Time and Sound. Some optimise options are not available on certain cycles to ensure optimal wash results.
Pre wash	Add a pre wash to remove excess soil and ensure optimal wash results. To prevent fading, we recommend using a cold pre wash for dark and coloured items. Not available with Manual dispensing.
Cold wash	Use cold wash to minimise energy usage. If you live in a colder climate, you can change the temperature to a controlled 20°C so wash performance is not affected. See 'Adjust settings.'
Soak	Add extra time for items to soak halfway through the wash cycle. Ideal for helping to lift stubborn stains.
Extra rinse	Add an extra rinse to the cycle. Ideal for people with sensitive skin, or for heavily soiled items.
Sanitise	Select your preferred method when treatment is set to Sanitise. <ul style="list-style-type: none"><li>• UV uses ultraviolet light to eliminate bacteria without high temperatures. UV sanitise is not recommended for light sensitive fibre types such as silk, wool and cashmere.</li><li>• HOT WATER is an extra hot treatment ideal for items that can handle high temperatures, like tea towels, dishcloths, towels and sheets.</li></ul>
Crease free	After the cycle is complete, the load will continue to tumble periodically to help reduce creases. Crease free will remain active for up to 12 hours or until cancelled. To cancel, touch the screen or open the door.
Drum dry	Runs the fan and periodically rotates the drum to reduce dampness once laundry is removed after a cycle. To activate, remove laundry, close the door and press START.

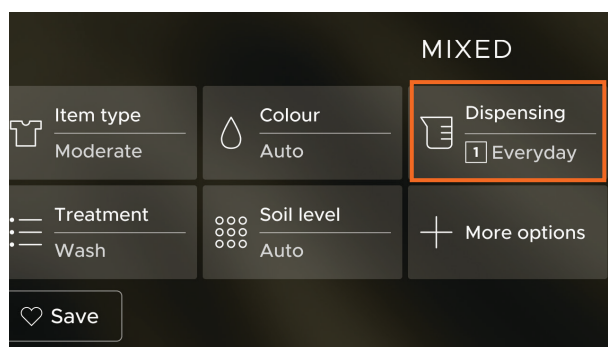

1. Press MORE OPTIONS to access extra wash options.

## MORE WASH OPTIONS



2. Select a wash option and follow the onscreen instructions to set it. Press DONE to confirm.

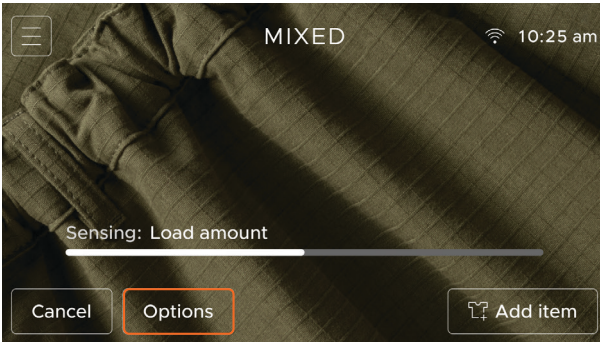

3. Press OPTIONS from the cycle screen to review your settings.

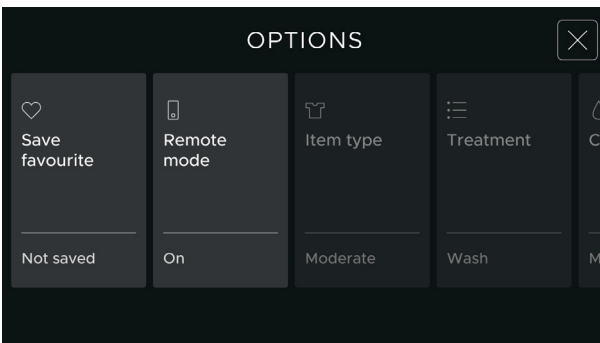

4. From the OPTIONS menu, you can also save your settings as a favourite and access remote mode.

## SET A DRY CYCLE

Your dryer has specialised cycles for specific fibre types. Start by selecting a fibre type, then select an item type based on durability or specific items, such as sheets or towels, and the required treatment. You can also adjust additional settings for dryness and time. The available cycle options may vary depending on the fibre type you select.

See 'Cycle selections' for details.

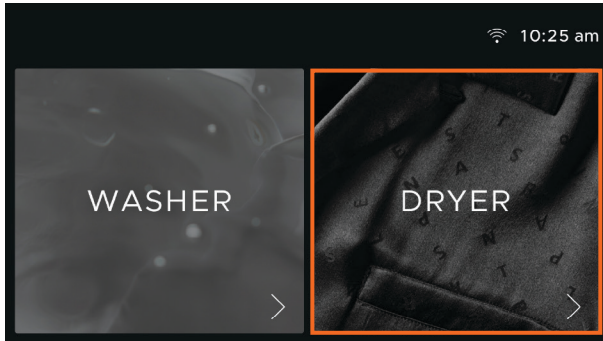

1. Select DRYER from the home screen.

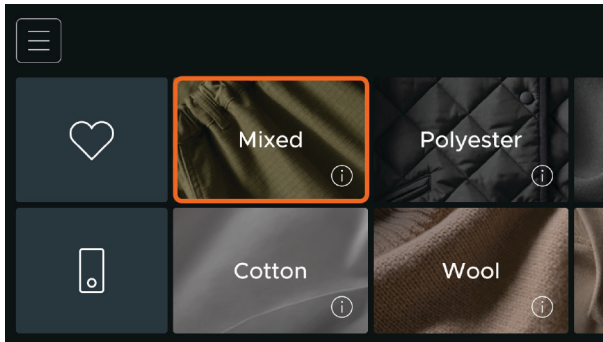

2. Select a fibre type.  
Press INFORMATION (i) for a description of each fibre.

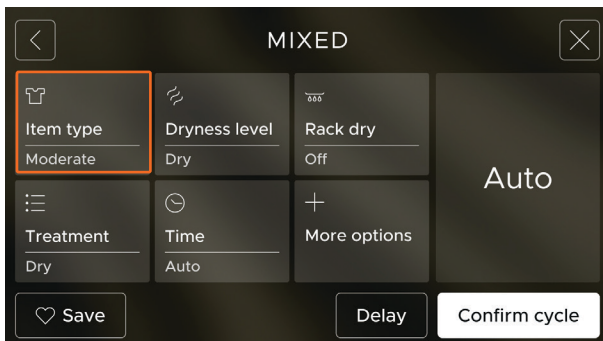

3. Press ITEM TYPE to access the options and see a description and examples for each type. Scroll to select an item type.

## SET A DRY CYCLE



4. Press **TREATMENT** to access the options and descriptions. Scroll to select a treatment.



5. Select a **DRYNESS LEVEL** or select **RACK DRY** for items that cannot be tumbled. See 'Fit drying rack' for how to fit the rack.

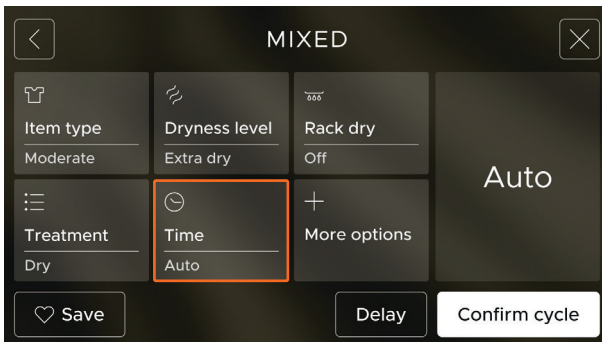

6. Set a drying duration or Auto. Press **MORE OPTIONS** to access additional drying options. See 'Drying options' for details.

## SET A DRY CYCLE

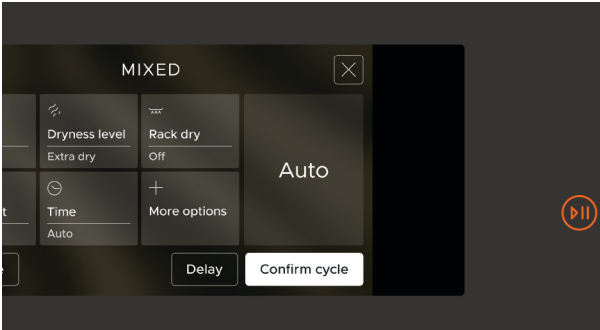

7. Press CONFIRM CYCLE, then press the START/PAUSE ▶|| button to begin the cycle.

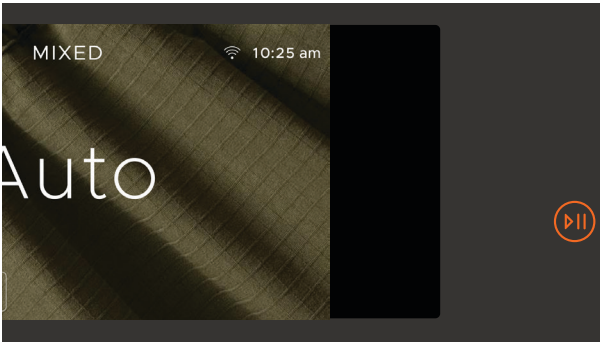

### Pausing the cycle

Press the START/PAUSE ▶|| button to pause the cycle if you want to add or remove an item.

Press RESUME, then the START/PAUSE ▶|| button to resume the cycle.

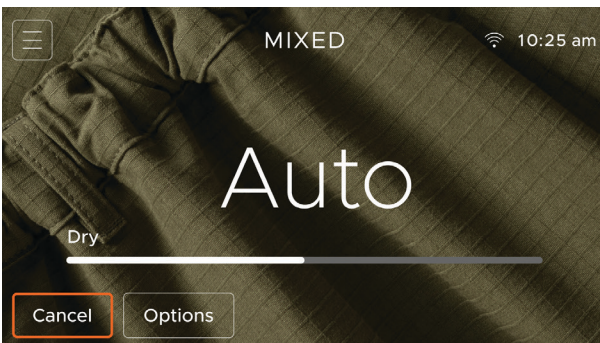

### Cancelling the cycle

Press CANCEL to cancel the cycle.

Remove items immediately and spread them out to cool. Take care as the drum and items may be hot.

## FIT DRYING RACK

The drying rack is designed for items that cannot be tumbled. Fit the drying rack when you use the RACK DRY option. You must set a cycle duration when RACK DRY is selected as DRYNESS LEVEL is not available. Rack folds for easy storage.



1. Fold the rack slightly and place it inside the dryer drum.



2. Press down on the centre of the rack so it lies flat and level. Follow the onscreen instructions to confirm the rest of the settings and begin the cycle.



3. When drying sneakers, check them throughout the cycle. Save as a Favourite if intending to use this cycle regularly.

## MORE DRY OPTIONS

### Crease free

After the cycle is complete the load will continue to tumble periodically to help reduce creases. Crease free will remain active for up to 8 hours or until cancelled. To cancel, touch the screen or open the door. Defaults to ON for some cycles.

### Iron ready alert

Set an alert for when the load reaches the iron ready dryness stage. Pause the cycle to remove items that do not need further drying. Resume the cycle to continue drying the remaining load.

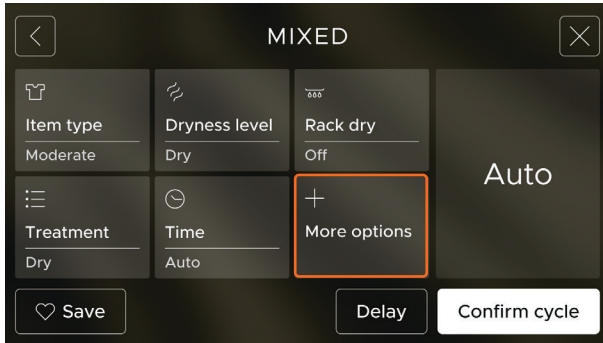

1. Press MORE OPTIONS to access additional cycle options.

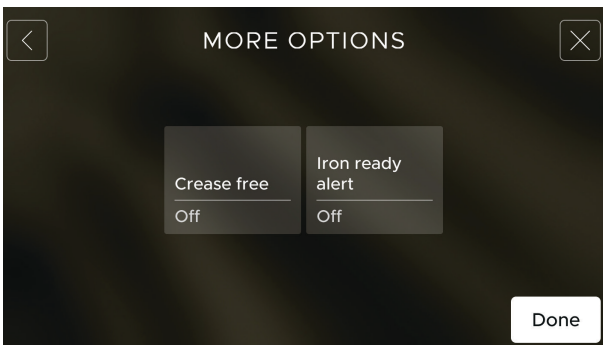

4. Select an option and follow the onscreen instructions to set it.  
Press DONE to confirm.

## SET DELAYED START

DELAY allows you to schedule a cycle to begin at a later time. You can set a time on the washer or start a cycle remotely through the app.

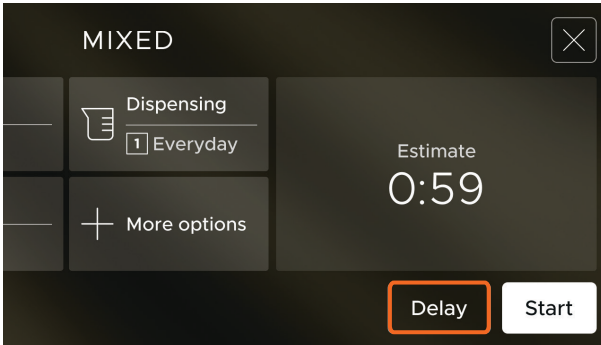

1. After setting the cycle, press DELAY to open the Delay screen.

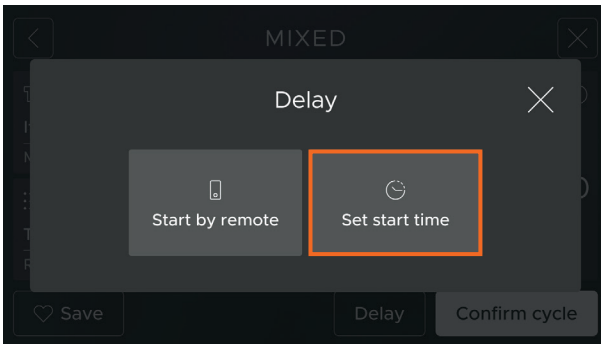

2. Press SET START TIME and follow the onscreen instructions to set a delayed start time.

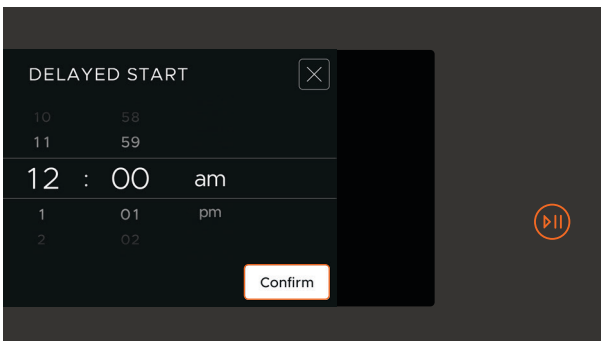

3. Press CONFIRM to save the new start time, then press the START/PAUSE button.

## SAVE FAVOURITE CYCLES

Save your favourite cycles for a quick start to wash and dry cycles. Favourites comes with preset QUICK 15 and QUICK 30 cycles for the washer and preset DELICATE REFRESH COTTON cycle for the dryer. You can save more on the appliance and manage them in the app.



1. Press **SAVE**  from the cycle settings screen, from the Options menu or at the end of a cycle to add the cycle to Favourite.



2. Create a custom name for your cycle, or skip that step and save it with a default name.

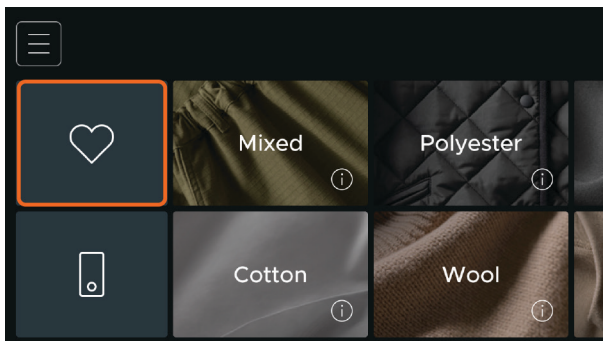

3. Press **FAVOURITE**  on the washer or dryer home screen to access your saved favourite cycles.

## SAVE FAVOURITE CYCLES



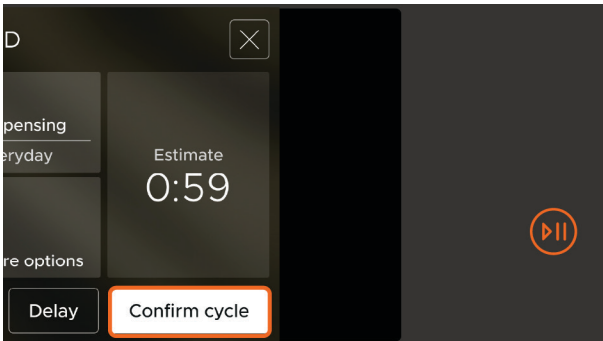

4. Select a favourite cycle from the Favourites menu.

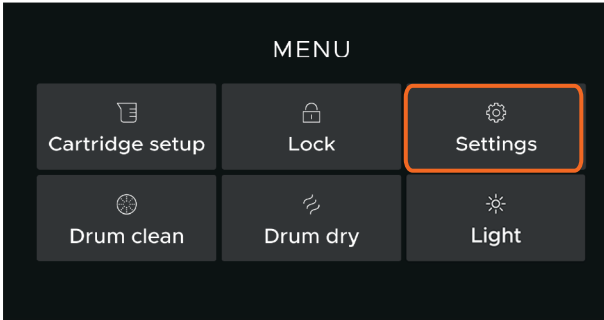

5. Press CONFIRM CYCLE, then press the START/PAUSE ▶|| button to start the cycle.

## ADJUST SETTINGS



Go to MENU  and select SETTINGS.

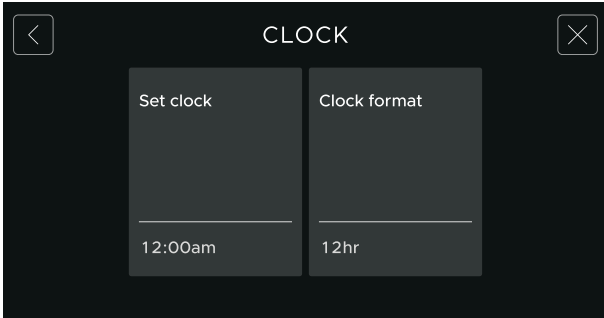

**Clock**  
Set time, format and time zone.  
Time updates automatically when connected to Wi-Fi.

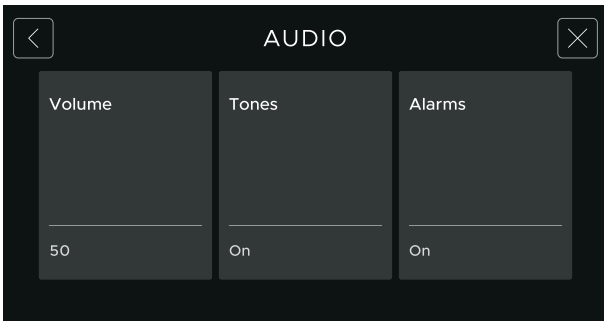

**Audio**  
Set volume or turn sounds on or off.

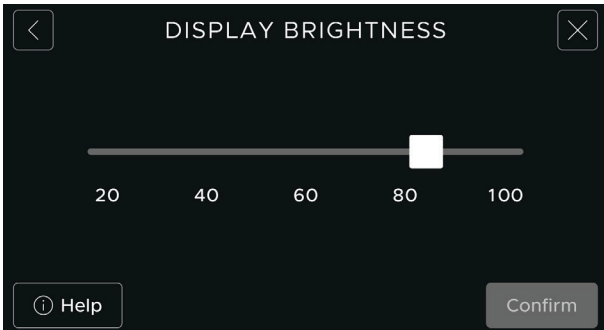

**Display**  
Adjust the brightness of the display screen. Set a lower brightness to improve energy efficiency.

## ADJUST SETTINGS

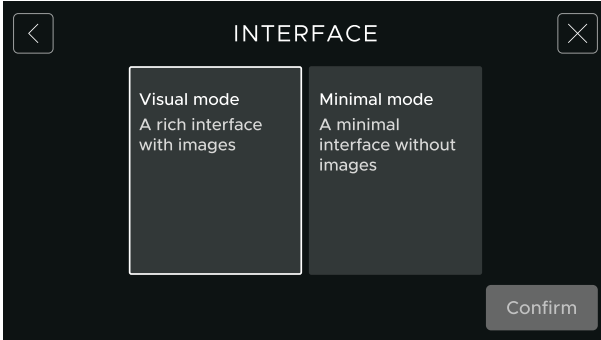

### Interface

Set visual or minimal modes on the display.

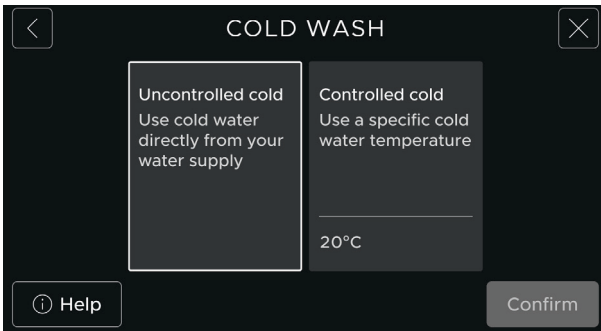

### Cold wash

Set the temperature for Cold wash. Use Controlled 20°C for colder climates if you notice changes in performance.



### Factory default reset

Restore all settings to factory defaults.

This action cannot be undone.

## WI-FI CONNECTION AND REMOTE MODE

Connect your appliance to your home wireless network to access extra features, receive updates and operate the appliance remotely using the app.



### Connect to Wi-Fi

1. Go to the menu and select **SETTINGS**, **WI-FI**, then **WI-FI SETUP**.

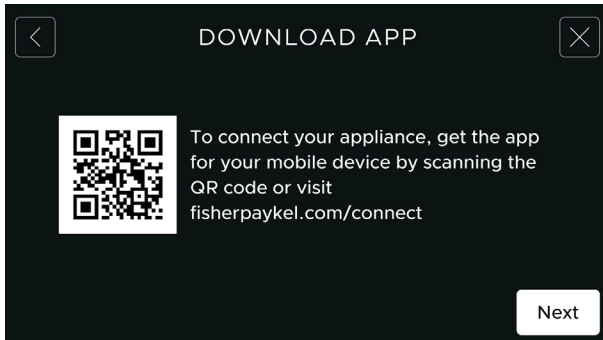

2. Download the app, and follow the app instructions.

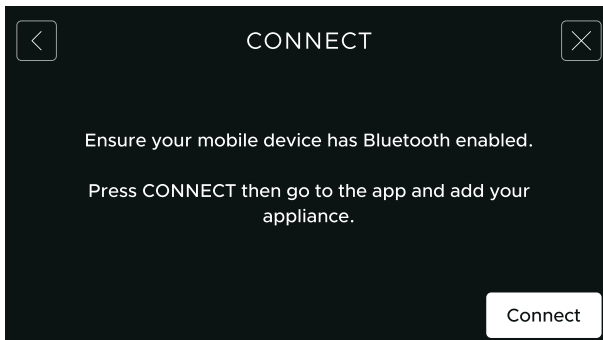

3. Enable Bluetooth on your mobile device, then press **CONNECT**.

Go to the app to complete the connection.

## WI-FI CONNECTION AND REMOTE MODE

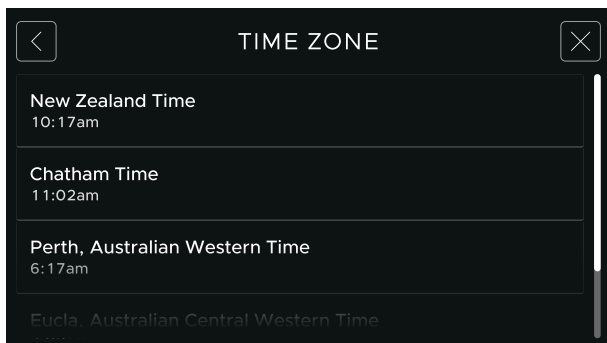

4. On your appliance, select the relevant time zone.



### Disconnect Wi-Fi

Go to **SETTINGS** and select **WI-FI**, then **RESET** to disconnect.

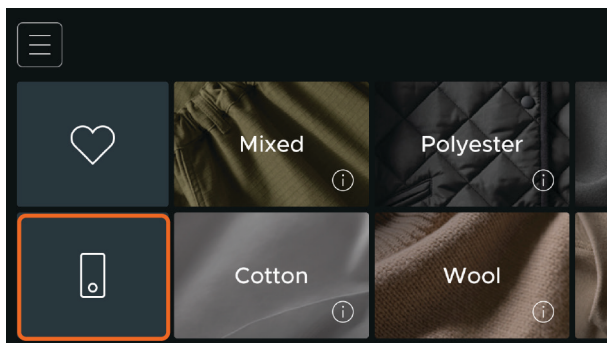

Enable Remote mode from the washer or dryer screen

Press **REMOTE** , then **ENABLE**.

Press the **START/PAUSE**  button to enable Remote mode and manage cycles in the app.

## WI-FI CONNECTION AND REMOTE MODE

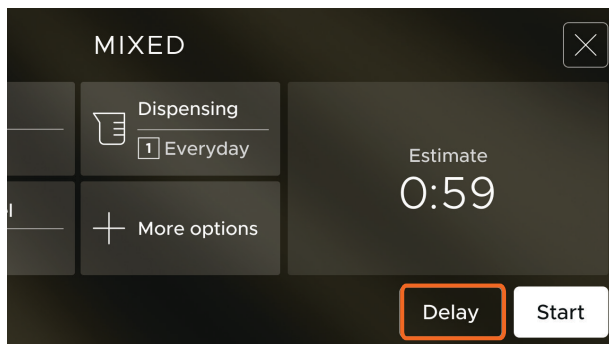

Enable Remote mode during cycle setup

1. Press DELAY in the cycle setting screen.

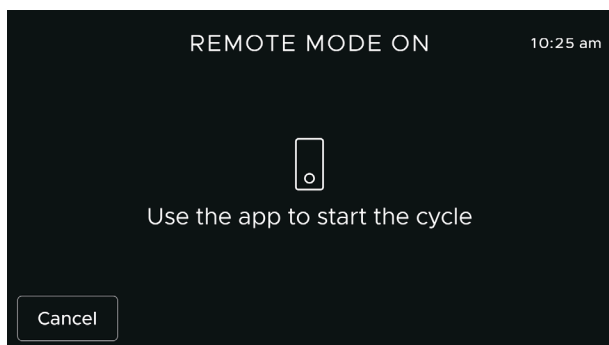

2. Press START BY REMOTE, then press the START/PAUSE button to enable Remote mode and manage cycles in the app.

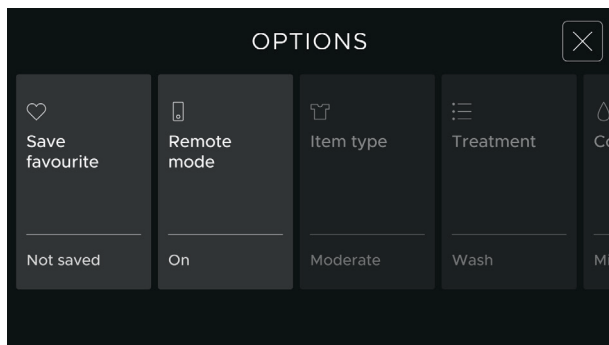

Turn Remote mode off

While a cycle is running, press OPTIONS, then REMOTE MODE to turn off, or open the washer door.

## CYCLE SELECTIONS

---

### FIBRE TYPE - WASHER AND DRYER

Select the specific fibre type that matches the load or choose the fibre type that applies to the most delicate fibre. The cycle will adjust to suit.

#### Mixed

For everyday mixed loads with a variety of fibres, and for cotton-polyester blends.

#### Cotton

For 100% cotton items, cotton blends and compatible fibre types.

#### Polyester

For 100% polyester items and compatible fibre types. Polyester is a synthetic fibre that is durable, wrinkle resistant and quick drying. It is widely used in everyday clothing for easy care and long-lasting wear.

#### Elastane

For items containing 10-50% elastane fibre, also known as spandex. A stretchy and resilient fibre, elastane provides ease of movement in close-fitting items and is often found in activewear and leggings.

#### Down

For items containing down fill. Down is soft and insulating and is harvested from the undercoat of ducks or geese. Down is commonly used in jackets and bedding for its warmth and lightness.

#### Silk

For 100% silk items and silk blends. Silk is a natural fibre produced by silkworms. It is soft, smooth and luxurious, and requires specialised care. Silk is often found in dresses, skirts and blouses for its luxury feel or in undergarments, sleepwear and bedding for its breathability and comfort.

#### Linen

For items containing linen fibre. Linen is a natural fibre made from the flax plant and is strong, breathable and moisture wicking. Linen is often found in summer clothing and in bedding.

#### Nylon

For items that contain majority nylon fibre. Nylon is a synthetic fibre that is strong and quick drying. Nylon is commonly found in activewear and outerwear due to its strength and durability.

#### Viscose

For items containing viscose fibre, also known as rayon. Viscose is a soft and breathable fibre made from wood pulp, and is often found in dresses and blouses due to its draping properties and silky feel.

## CYCLE SELECTIONS

---

### Acrylic

For items made from acrylic fibre. Acrylic is a synthetic fibre that is lightweight and warm, and often used in knitwear.

### Hemp

For items containing hemp fibre. Hemp is a natural fibre made from the hemp plant and is strong, breathable and absorbent. Hemp is often found in casual and sustainable clothing lines.

### Lyocell

For items containing Lyocell fibre. Lyocell is a soft, breathable and absorbent eco-friendly fibre made from wood pulp.

### Ramie

For items containing ramie fibre. A strong and absorbent natural fibre made from the nettle plant, ramie is often found in summer garments.

### Cashmere

For items containing cashmere wool fibre. Cashmere is found in items like sweaters and scarves, and offers luxurious softness and warmth.

### Wool

#### Woolmark Wool Care Black (available with Delicate Item type)

For 100% woollen items and wool blends. This cycle meets the Woolmark requirements for washing and drying items labelled “machine wash”.

#### Woolmark Wool Care Green (available with Ultra delicate item type)

For 100% woollen items and wool blends. This cycle meets the Woolmark requirements for washing items labelled “hand wash only”.

#### Woolmark Wool Care Blue (available with Ultra delicate item type)

This cycle meets the Woolmark requirements for drying for items labelled ‘hand wash only’.

Washing underlays and sheepskins is not recommended because they could produce excessive amounts of lint that may cause pump blockages.

---

## WASHER

### ITEM TYPE

Item Type relates to the durability of items in your load. Wash garments and items of similar durability together.

### Durable

Strong and resilient items like workwear and outerwear.

## **CYCLE SELECTIONS**

---

### **Moderate**

Everyday items like t-shirts, shorts and pants.

### **Delicate**

Light and easily damaged items like dress shirts, blouses, dresses and other items.

### **Ultra delicate**

For items that are very fragile, needing extra gentle care. Ideal for lace, lingerie and fine knitwear.

Available via **MORE ITEMS:**

### **Sports**

Durable sportswear items made from synthetic fibre blends.

### **Denim**

Denim or stretch denim items like jeans, jackets and skirts.

### **Sheets**

Items such as bed sheets, pillow cases and duvet covers.

### **Towels**

High absorbency towelling fabric items like bath, beach and hand towels.

### **Bulky**

For items that are thick and insulating, such as blankets, quilts, comforters, and duvet or doona inners.

### **Outdoors**

For outdoor items made from weather-resistant materials, such as rain jackets, windbreakers and pants.

### **Soft toys**

For plush items filled with soft stuffing such as soft toys. This cycle is suitable for up to four items at a time.

### **Shoes**

For sneakers and sports shoes with textile or canvas uppers. For best results, add some old towels to help with extra cleaning. Can wash up to two pairs at a time.

---

## CYCLE SELECTIONS

---

### TREATMENT

Treatment lets you select from a range of specialised wash treatments to suit your needs.

#### Wash

A tailored wash, rinse and spin based on fibre and item type selection to remove soils. Detergent dose, water temperature, wash times, tumble patterns and spin speeds are optimised based on fibre type, item type and load size to ensure perfect results.

#### Steam refresh

Designed to refresh dry items using steam and tumbling to reduce creases and odours. For best results use this cycle for one or two items at a time. Ideal for items like dress shirts to refresh before ironing.

#### Sanitise

Designed to eliminate bacteria and sanitise items using either ultraviolet light or high temperatures. Hot Sanitise is ideal for sanitising items, like tea towels, dishcloths, towels and sheets, that can handle high temperatures. We recommend UV Sanitise for delicate items.

#### Stain care

Use to help remove stubborn stains. The wash will be adjusted to optimise stain removal depending on the stain type selected. See 'Stain Care treatments' for details.

#### Rinse

A tailored rinse and spin based on fibre and item selection. Removes detergent and prepares items for drying.

#### Spin

A tailored spin based on fibre and item selection. Items are spun at an optimised speed to remove excess moisture. Ideal for preparing clothes for drying.

#### Allergy Care

Uses higher wash temperatures and additional rinse cycles to reduce detergent residue and allergens like dust mites and pollen. Ideal for helping to manage allergies or sensitive skin.

#### Proofing

Prepares waterproof items for manual waterproofing or for applying in-wash waterproofing agents. See 'Proofing treatments' for details.

## CYCLE SELECTIONS

---

### COLOUR

Different colours require different care. Colour selection adjusts the wash temperature automatically to suit the items in the load. Always separate dark colours from white and light colours.

#### Dark

Designed to care for dark-coloured items with a cooler wash to help preserve vibrancy and prevent fading.

#### Mixed

Designed to care for loads with a mixture of darker colours. Ideal for everyday laundry loads, providing a balanced wash temperature to preserve vibrancy and help prevent colour transfer.

#### Light

Designed to care for light-coloured items with an optimised wash temperature to help maintain brightness.

#### White

Designed to care for white items with an optimised wash temperature to help maintain whiteness.

---

### SOIL LEVEL

Soil Level adjusts the wash cycle based on the soil level of items. Leave on Auto or select a soil level to suit the load. The wash time and detergent dose will automatically adjust to suit your selection.

#### Auto (default)

Senses the dirt levels in a load. The wash time and detergent dose will adjust automatically for optimal cleaning efficiency.

#### Heavy

For items with high levels of soiling, using higher detergent dosage and longer wash times.

#### Moderate

Ideal for everyday laundry loads, providing a balanced wash cycle with optimal detergent dosage and wash time.

#### Light

For items with low levels of soiling, reducing detergent dosage and wash time.

## CYCLE SELECTIONS

---

### DRYER

#### ITEM TYPE

Item type relates to the durability of items in your load in terms of fabric thickness.

Dry garments and items of similar thickness together to prevent some items becoming over-dried while others are still damp.

#### Ultra delicate

For items that are very fragile, needing extra gentle care. Ideal for lace, lingerie and fine knitwear.

#### Delicate

Light and easily damaged or torn items like blouses, dresses and other items.

#### Moderate

Everyday items like t-shirts, shirts, lined dresses, shorts and pants.

#### Durable

Strong and resilient everyday items like workwear and outerwear.

#### Denim

Items made of denim or stretch denim such as jeans, jackets and skirts.

#### Towels

High absorbency towelling fabric items like bath, beach and hand towels.

#### Sheets

Items such as bed sheets, pillow cases and duvet covers.

#### Bulky

**Cotton/Mixed/Polyester** - For items that are thick and insulating, such as blankets, quilts, comforters, and duvet or doona inners.

**Down** - For smaller thick and insulating items like jackets and sleeping bags.

#### Quilts and duvets

For larger thick and insulating items like quilts, comforters and duvet inners.

#### Sportswear

Durable sportswear items made from synthetic fibre blends.

#### Outdoors

For outdoor items made from weather-resistant materials, such as rain jackets, windbreakers and pants.

## CYCLE SELECTIONS

---

### Soft toys

For plush items filled with soft stuffing such as soft toys. This cycle is suitable for up to four items at a time.

### Shoes

For sneakers and sports shoes with textile or canvas uppers. Rack dry only. For best results, use this item type for up to two pairs at a time.

---

## TREATMENT

### Dry

Designed for everyday drying.

### Rack dry

For items that cannot be tumbled. This option requires the drying rack to be fitted.

### Steam refresh

A steam treatment to refresh 1 to 3 dry items.

### Sanitise dry

High temperature drying to reduce bacteria. Ideal for towels and sheets, but unsuitable for delicate items.

### Allergy care

Uses sustained higher temperatures to reduce allergens like dust mites and pollen. Ideal for helping to manage allergies or sensitive skin.

---

## METHOD

You can select a drying method that automatically ends the cycle when the load reaches the selected dryness level or after a set duration.

### Auto

Ends the cycle automatically when the load reaches the selected dryness level. You will be prompted to select a dryness level for the next step.

Not available for Wool cycle.

### Time

Ends the cycle after a set duration. You will be prompted to set a drying duration for the next step. Dryness level is not available with this option.

## **CYCLE SELECTIONS**

---

### **DRYNESS LEVEL**

Dryness options let you select a dryness level that prepares items for storing, wearing or ironing. Sensors in the dryer can detect remaining moisture in the load and will end the cycle when the load reaches your preferred dryness level.

Not available if drying method is set as Time.

#### **Iron ready**

Leaves some moisture in the load to help reduce wrinkles and prepare items for ironing.

#### **Dry**

Dries the load thoroughly leaving items ready to wear.

#### **Dry plus**

Dry plus is ideal for thicker fabrics or absorbent items that might need extra drying time.

#### **Extra dry**

An ultra-dry option for thick or heavy items. Ideal for thick or heavy items, or items that are going to be placed in storage.

# WASH TREATMENTS

## WASH TEMPERATURES AND SPIN TREATMENTS

Wash temperatures and spin speeds are set automatically based on your fibre, item type and colour selections. This ensures the best wash results for your items. See below for a general guide to how colour selection affects wash temperature and how item type affects spin speed. Not applicable to all fibre types.

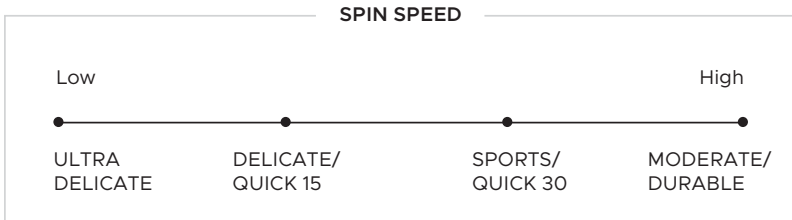
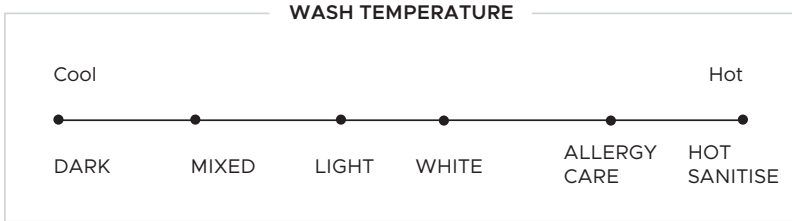

## STAIN CARE TREATMENTS

Stain care treatments allow you to target and remove stains using specialised stain care techniques. The wash temperature and pre wash settings adjust based on the stain type you select. Some cycle settings will be unavailable when Stain Care is selected.

### Key steps for removing stains

- 1 Treat stains as soon as possible.
- 2 If using a stain removal product, do this as a pre-treatment to the stain care treatment. Do not add it to the washer.
- 3 Run a Stain Care treatment.
- 4 If needed, repeat the stain care treatment until the stain is removed.
- 5 Avoid ironing or steaming the item until the stain is removed.

### Oil based

Oil-based stains don't dissolve well in water. This stain care treatment loosens the stain without melting it into the fabric and spreading it deeper, and it uses detergent to dissolve the fats. It is important to treat oil-based stains quickly because they can turn yellow over time and become even harder to remove.

Oil-based stains can include oil, butter, waxes, crayons, animal fat, food grease, sun screen, sweat and collar stains.

# TREATMENTS

---

## Protein based

Protein-based stains are sensitive to heat which can cause them to set into the fabric. It is important to treat them as soon as possible. This stain care treatment modifies temperature to prevent the stains setting.

Protein-based stains include dairy products, grass, eggs, meat and blood.

## Inorganic based

Inorganic stains are made of fine particles that attach to fabric. This stain care treatment controls tumbling and detergent amount to detach the particles from the fabric.

Inorganic based stains include dirt, mud, clay, ink, chalk and makeup.

## Pigment and tannin based

Pigments and tannins are typically strong-coloured stains. This stain care treatment helps remove the pigments from the fabric, but in some cases, a bleaching agent is required to remove the colour completely. This can be done as a pre-treatment before washing.

Pigment and tannin-based stains include tea, coffee, wine, beer, berries, fruits, vegetables, juice and chocolate.

## Starch based

Starches are commonly found in food products and can trap other stains to fabric. This stain care treatment uses detergent to dissolve the starch and helps to release other stains so they can be washed off the fabric.

Starch-based stains include baby food, tomato sauce, BBQ sauce, pasta sauce, condiments and gravy.

## TREATMENTS

### PROOFING TREATMENT

Proofing treatment prepares waterproof items for spray-on or in-wash waterproofing. It is only available with the **OUTDOORS** item type. Follow the manufacturer's instructions when applying a proofing agent. If recommended, fix or activate the proofing agent in the dryer after the proofing treatment.



#### Pre-proofing only

To pre-proof an item before applying a spray-on proofing agent, place 1 to 2 items in the washer and run the proofing cycle to clean them.

After the cycle, apply the proofing agent to the item according to the product instructions.

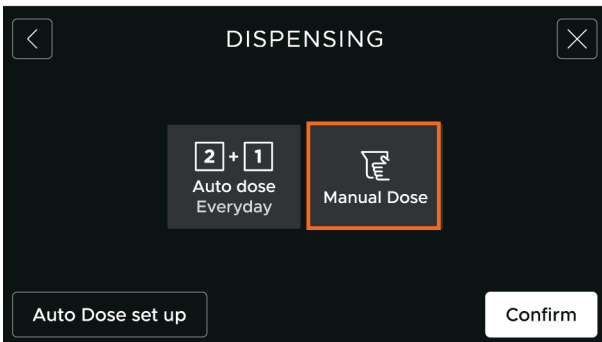

#### In-wash proofing

Set dispensing to **MANUAL**, and add the recommended amount of proofing agent to the Manual Dose dispenser tank.

Place 1 to 2 items in the washer, select **PROOFING** from the Treatment options, then start the cycle.

## CHOOSE A DETERGENT

---

Specialised detergents provide the best wash performance for different items. We recommend using a specialised detergent type where relevant.

If switching detergent types between loads, we recommend cleaning the dispenser drawer to remove unsuitable detergent before washing items with a specialised detergent. See 'Clean the dispenser drawer'.

### Everyday

For your everyday items that do not require specialised care.

### Darks

Dark detergents are specially designed to keep darks vibrant and prevent dye transfer during the wash. Avoid using darks detergents with white or light-coloured items.

### Whites

Whites detergents are designed to brighten your white items as they typically contain whitening agents. Avoid using whites detergents with coloured or dark items.

### Sensitive

For items of users with sensitive skin. Sensitive detergents are typically free from fragrance and colourants, safer for those with allergies or asthma, and ideal for baby clothes.

### Delicates

For delicate and ultra-delicate fabrics. Delicate detergents preserve fibres while maintaining softness.

### Wool

Wool detergents are ideal for all types of woollen items to gently clean and maintain softness.

### Silk

Silk detergents are ideal for washing item types containing silk fibres, preserving fibres while maintaining softness and lustre.

### Down

Down detergents gently clean filled down garments, restoring loft, removing odours and revitalising water repellency. May be suitable for synthetic-filled garments.

### Softener

Softeners are for conditioning items, giving them a softer feel. Softeners are dispensed during the rinse phase to prevent mixing with detergents.

# CLEAN AND MAINTAIN YOUR WASHER AND DRYER

---

## GENERAL

### Surfaces and accessories

Wipe with a damp cloth and dishwashing liquid, then dry with a clean, lint-free cloth. We do not recommend using the following cleaning products as they may cause damage:

- Plastic or stainless steel scouring pads
- Abrasive, solvent, household cleaners
- Acid or alkaline cleaners
- Handwash or soap
- Stainless steel cleaners or polishes
- Laundry detergents or disinfectants

## WASHER

### Cleaning the drum and the door

- Run the Drum Clean cycle.
- Wipe the rubber seal around the door to prevent odours. Remove any items or lint and wipe out any water.
- Remove dirt or lint from the drum and wipe it clean. Do not leave metal objects in the drum as these may rust and cause staining.
- Leave the door open when not in use to prevent odours. Keep children and pets away from the washer so they cannot become trapped inside it.

### Cleaning the hose(s)

Each hose contains a filter to stop contaminants in the water from entering your washer. Occasionally, disconnect the hoses where they connect to the taps and wash out any dirt build-up.

### Moving your washer

- Remove the dispenser drawer and empty out any detergent or softener. Refer to 'Clean the dispenser drawer.'
- Clean the pump filter and ensure any water in the washer is drained. Refer to 'Clean the pump filter'.

### Products that might damage your washer

- Concentrated bleaches, laundry pre-soakers/sanitiser, stain removers and hydrocarbon solvents (eg petrol and paint thinners) can cause damage to the surfaces eg control panel, and components of your washer.
- Be careful when washing items stained with solvents as they are flammable. DO NOT put them in your dryer.
- Use of dyes in your washer may cause staining of the plastic components. The dye will not damage the washer but we suggest you thoroughly clean your washer afterwards. We do not recommend the use of dye strippers in your washer.
- Nappy sanitiser and bleach are very corrosive to metal surfaces. DO NOT tip the contents of a nappy bucket into your washer. Rinse and wring items out thoroughly before placing them in the washer.

## CLEAN AND MAINTAIN YOUR WASHER AND DRYER

---

### DRYER

#### Inside the dryer

Check and clean the inside of the drum regularly with a damp cloth to remove any dirt or lint. Do not leave any metal objects in the drum as these may cause rust.

#### Sensors

The sensors are located behind the lint filter and detect whether the laundry is dry or not. Clean the sensors regularly to maintain drying performance.

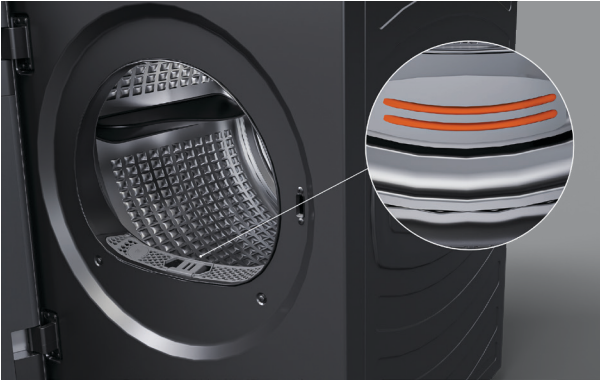

#### Cleaning the sensors

Wipe clean with a soft, damp cloth.

## CLEAN THE WASHER DISPENSER DRAWER

Check and clean the dispenser and cartridges regularly to remove build-up. Wash cartridges thoroughly if you reset to a different detergent. You can remove the drawer if required.



### Removing the drawer

1. Open the dispenser drawer fully, then tilt it up to remove.



2. Lift out the cartridges and remove the fittings from the end. Wash the cartridges and fittings in warm water. Use a soft brush to remove stubborn build-up. Dry each part thoroughly, then put the fittings back in the cartridges.



3. Fill cartridges with their assigned detergents, and fit them back in the drawer as required. Push the drawer to close.

Store unused cartridges level if they have detergent in them.

## RUN THE WASHER DRUM CLEAN CYCLE



DRUM CLEAN is a hot water cycle designed to be used with Washing Machine Cleaner to remove any buildup and odours. A reminder will display after 100 cycles.

Run the drum clean cycle when you see the reminder or more frequently if you use Eco or liquid detergents and low-temperature cycles.

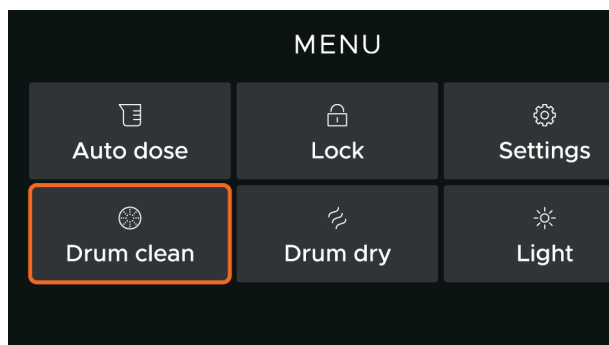

1. Ensure the drum is empty, then add Washing Machine Cleaner directly into the drum. Follow the manufacturer's instructions for recommended dosage.



2. Go to MENU  and select DRUM CLEAN. Press CONFIRM, then press the START/PAUSE  button to begin the cycle.

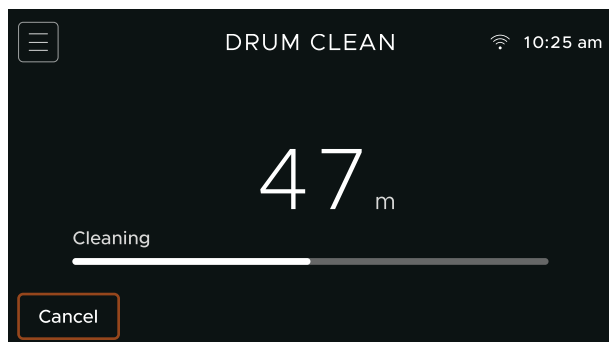

3. The cycle progress will show on the display. Press CANCEL to cancel the cycle.

## UNLOCK THE WASHER DOOR

In a power failure, you can use the door-release tab to unlock the washer door and remove items, but you must drain the washer first.

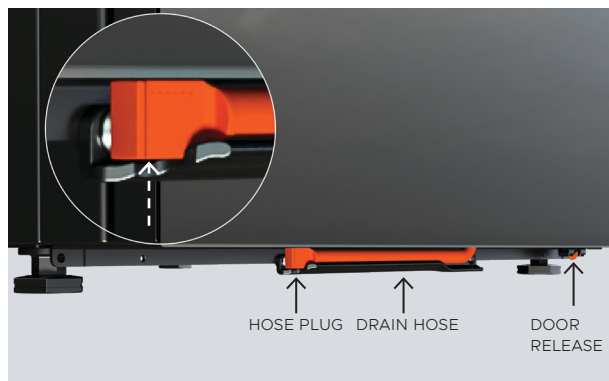

1. Use your fingers to lift the drain hose at the plug end and unhook it from under the washer.

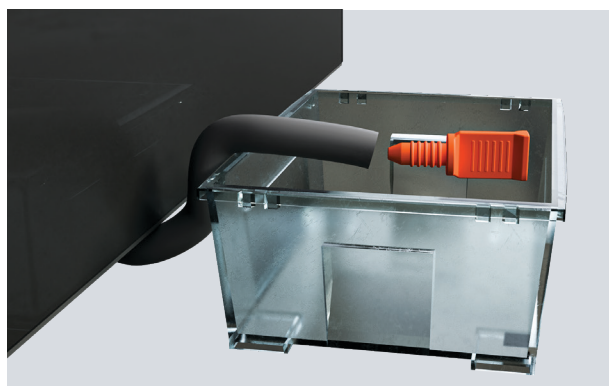

2. Position the hose over a shallow container, and remove the hose plug. Drain water from the washer so it is safe to open the door.

Replace the plug after draining, and refit the hose in its housing.



3. Use a suitable tool to pull down the door-release tab and unlock the door.

Hold the tool parallel to the floor, place your hand on top of it, and push downward to lower the tab.

Do **not** use the door as a lever point.

## CLEAN THE WASHER PUMP FILTER

Check and clean the pump filter when you see an onscreen alert or you notice the washer is not draining. Turn the washer off at the wall before you remove any parts, then drain the washer.



1. Unlock and open the door, then push on the filter cover to access the filter.

See 'Unlock the door' for how to drain the washer and unlock the door.

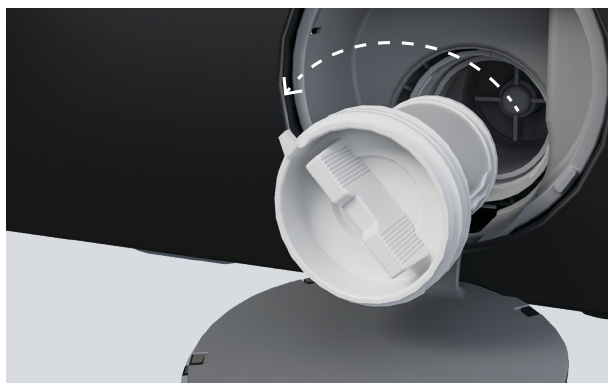

2. Turn the filter anti-clockwise to remove it, then clean and rinse it.

Some water may leak out when you remove the filter.



3. Check and clear the cavity behind the filter, and check that the impeller in the cavity moves freely.

## CLEAN THE WASHER PUMP FILTER

---



4. Refit the filter, and turn it clockwise until the handle is in the vertical position.

## CLEAN THE DRYER LINT FILTERS

---

### Lint filter

The CLEAN LINT FILTER reminder will pop up at the end of a cycle. Remove and clean the filter each time you use the dryer as blocked filters will reduce drying performance, and lint can become a fire hazard if it builds up in or around your dryer.



1. Open the dryer door and remove the lint filter.

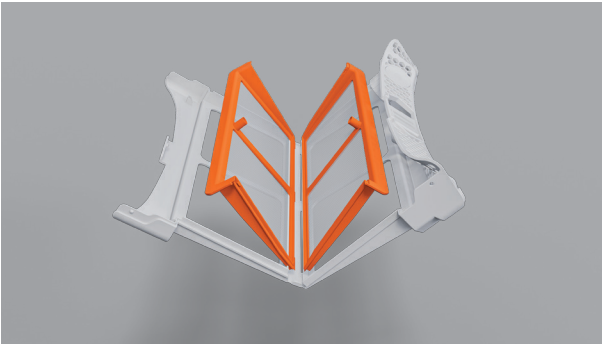

2. Open the filter and separate the parts. Use your hand or a soft cloth to remove the lint from both parts.

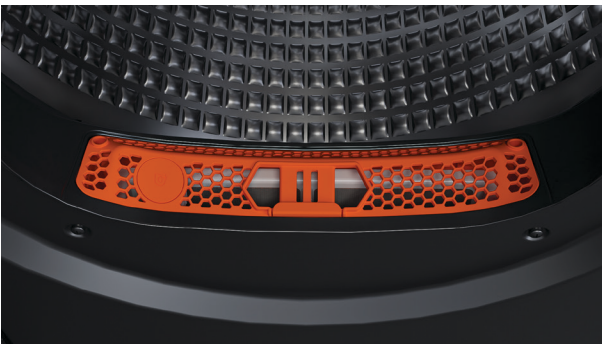

3. Refit the internal filter part to the outer part, then close the filter and place it back in the dryer.

## CLEAN THE DRYER LINT FILTERS

---

### Lower lint filter

The lower lint filter sits below the lint filter. The CLEAN LOWER LINT FILTER reminder will pop up after every 10 cycles to prompt you to remove and clean the lower filter. Clean it when the reminder pops up, or when you notice the drying cycle is taking longer than usual. This will help to maintain drying performance.



1. Remove the lint filter to access the lower lint filter.



4. Remove the lower lint filter, open it and take out the foam.

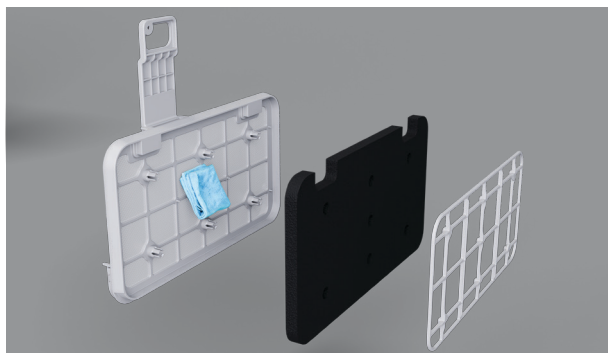

5. Use a cloth or vacuum cleaner to remove lint, then refit the foam to the mesh. Place lower filter back into the dryer, and refit the lint filter.

## TROUBLESHOOTING

---



### Washer

---

#### Why will the appliance not turn on?

- No power. Check the appliance is connected to the power supply. Press POWER  to turn the appliance on.
- 

#### Why is the display not responding?

- Appliance needs time to start up when first powered on. This can take 30 seconds.
  - Appliance needs to be reset. Press POWER  to turn the appliance off. Wait a few seconds, then turn it back on. If the problem persists, disconnect from the power supply, wait a few seconds, then reconnect and press POWER  to turn it on.
  - Appliance may require a software update. Connect it to Wi-Fi and check for updates in the app.
  - Controls are locked. Press and hold the screen to unlock.
- 

#### Why can't I see all the cycle settings and features on my washer?

- Software needs to be updated. Connect your washer to the app to get the latest updates and access extra features. See 'Wi-Fi connection and remote mode'.
- 

#### Why is the washer not starting?



- Door not closed. Check nothing is obstructing the door, and close it firmly.
  - Cycle confirmed but not started. Press the START/PAUSE  button to start the cycle.
  - Washer is overloaded. Remove some items and restart the cycle.
  - Delay start is set. See 'Set Delay start'.
  - The controls are locked. Press and hold the screen to unlock.
  - Hot and cold taps not turned on. Turn on the hot and cold water and resume cycle.
  - There is a fault. See 'Fault codes'.
- 

#### Why is the washer stopping and starting?

CREASE FREE is turned on. Press options, then CREASE FREE to turn off.

---



#### Why did the washer stop mid-cycle?

- Cycle has been paused. Press RESUME then START/PAUSE  to resume the cycle.
  - The door is open. Close the door and press START/PAUSE  to resume the cycle.
  - Washer may have detected suds and is waiting for them to dissolve before continuing the cycle.
-

## TROUBLESHOOTING

---

### Why is the washer vibrating or making noises?

- Transit bolts may still be in place. Refer to installation guide for how to remove them.
  - Washer overloaded. Press **START/PAUSE**  to pause the cycle and remove some items.
  - Washer not level. Refer to installation guide for instructions about levelling the washer.
  - Load out of balance. Press **START/PAUSE**  to pause the cycle and redistribute items.
  - Washer is in **DRUM DRY** mode.
  - Washer has a fault. See 'Faults'.
- 

### Why is the wash cycle taking so long?

- Washer is overloaded. Pause the cycle and remove some items.
  - Items are tangled. Untangle the items and resume the cycle.
  - Incorrect settings for the load. Check the selected fibre type, item type and treatment and adjust if required.
  - Too much detergent is causing oversudsing. Washer will pause and wait for foam to dissipate before resuming the cycle.
  - Washer is not draining. Check the drain hose for blockages and correct if possible. If the problem persists contact Customer Care.
- 

### Why is the fabric damaged after a wash cycle?

- Cycle settings not appropriate for the load type. Follow instructions on care labels and sort items accordingly. See 'Sort your items'.
  - Metal parts on the items or in the load may catch on fabric. Always fasten zips, velcro and other clasps before placing items in the washer.
- 

### Why do items keep getting tangled?

- Loads not separated before going in the washer. Load items individually and try separating larger items from smaller items.
  - Load size is too large. Try washing smaller loads. See 'Load the washer'.
  - Wash big items like sheets and duvet covers separately and use the **Sheets** item type.
  - Cycle settings not the best option for the load type.
  - Delicate items not separated. Wash pantyhose, bras and stockings in a small washbag.
- 

### Why do items keep getting creased?

- Items have been left in the washer after the cycle ended. Turn **CREASE FREE** on at the start of the cycle to minimise creasing.
  - Washer is overloaded. Press  **ADD ITEM** to pause the wash and remove items. See 'Wash options'.
  - Select the **Delicate** or **Ultra Delicate** Item type. This will reduce spin speed and minimise creases.
-

## TROUBLESHOOTING

---

### Why is dye transferring between my items?

- Items not sorted before going in the washer. Separate white and coloured items into separate loads.
  - Cycle settings not appropriate for load type. Select the relevant COLOUR option for your load.
- 

### Why is the washer not draining?

- Pump filter needs to be cleaned. See 'Clean the pump filter.'
  - Drain hose not connected correctly. See the installation guide for instructions.
  - Drain hose or drain is blocked. Check the drain hose and drain for blockages and correct if possible. If the problem persists contact Customer Care.
- 

### Why is the washer beeping?

- The cycle has ended. Items can be removed.
  - Washer has a fault. See 'Faults'.
- 

### Why is water coming from under the washer?

- Door not closed. Check nothing is obstructing the door, and close it firmly.
  - Dispenser drawer not closed. Close it firmly.
  - Drain hose or drain is blocked. Check the drain hose and drain for blockages and correct if possible. If the problem persists contact Customer Care.
  - Drain hose not connected correctly. See the installation guide for instructions.
- 

### Why is my washing wetter than I expect at the end of the cycle?

- Out of Balance load affecting spin speed. Redistribute the load and run a spin treatment to remove excess water.
  - Quick or delicate cycles have lower spin speed and can result in wetter washing at the end of the cycle. Select Moderate and Durable treatments as these have faster and longer spin times.
- 

### Why are my clothes not as clean as I expected?

- Incorrect settings for the load. Select a higher SOIL LEVEL or more durable item type.
  - Not enough detergent. Increase detergent amount by increasing SOIL LEVEL or adjusting AUTO DOSE amount.
  - Washer overloaded so can't wash items properly. See 'Load the washer' for maximum load capacity guidance.
  - Ineffective detergent. Use a good quality detergent for best results.
  - Washer still has residue from previous wash. After washing particularly soiled clothing, empty the washer and run a RINSE cycle to remove residual dirt.
  - Use STAIN CARE treatment for specific stains.
-

## TROUBLESHOOTING

---

---

### Why is the remaining cycle time not accurate?

Cycle time is an estimate based on load size and water flow rates. It adjusts throughout the cycle to give you an estimation of minutes remaining. The time shown is not the Declared Program Time.

---

### Why does my item have wet patches on after a STEAM REFRESH cycle?

This is normal and helps remove wrinkles. Remove the item from the washer immediately at the end of the cycle and hang up to dry for a few minutes before wearing.

---

### Why does my washer smell after a cycle?

- Washer needs to dry out. Use DRUM DRY after a cycle, or leave the washer door ajar.
  - Drum and door need to be cleaned. See 'Clean and maintain your appliance'.
  - Try using a different detergent.
-

## TROUBLESHOOTING

---

### Dryer



---

#### Why will the dryer not turn on?

No power. Check the dryer is connected to the power supply.

---

#### Why is the display not responding?

- Dryer needs to be reset. Press and hold **POWER**  to turn the dryer off. Wait a few seconds, then turn the dryer back on. If the problem persists, disconnect the dryer from the power supply, wait a few seconds, then reconnect and press and hold **POWER**  to turn the dryer on.
  - Dryer may require a software update. Connect dryer to Wi-Fi and check for updates in the app.
- 

#### Why is the dryer not starting?



- Dryer door not closed. Check nothing is obstructing the door, and close it firmly.
  - Dryer is overloaded. Remove some items and restart the cycle.
  - Delayed start is set. See 'Setting Delayed start'.
  - The controls are locked. Press and hold the screen to unlock.
  - There is a fault. See 'Fault codes'.
- 

#### Why is the dryer stopping and starting?

The crease free setting is turned on. Turn off in Options. See 'Drying options'.

---

#### Why did the dryer stop mid-cycle?

- Drying cycle has been paused. Press **RESUME**, then **START/PAUSE**  to resume.
  - The door is open. Close the door and press **RESUME**, then **START/PAUSE**  to resume.
  - The lint filters need to be cleaned. Remove and clean the lint filters.
- 

#### Why is the dryer vibrating or making noises?

- Dryer is overloaded. Press **START/PAUSE**  to pause the cycle and remove some items.
  - Dryer is not level. Refer to installation guide for instructions about levelling the dryer.
  - The cycle has ended. Items can be removed.
  - The module has fallen into the load. Pause the dryer and find the module. Refit it inside top-right of the drum so it snaps into place. Resume the cycle.
  - Dryer has a fault. See 'Fault codes'.
- 

#### Why do the items feel damp after a drying cycle?

- Items are just warm and will feel dry once they have cooled down.
  - Incorrect drying settings for the load. Check settings and adjust if required.
-

## TROUBLESHOOTING

---

### Why is the drying cycle taking so long?

- Dryer is overloaded. Pause the cycle and remove some items.
  - Items are tangled. Untangle the items and resume the cycle.
  - Lint filters need to be cleaned. Remove and clean the lint filters.
  - Incorrect drying settings for the load. Check the selected fibre type, item type, treatment, method and dryness, and adjust if required.
  - Load was overly wet at the start of the cycle. Remove from dryer and run on a spin cycle in the washing machine to remove excess water.
  - Items are very large. Large items, like duvets, require longer drying times.
  - Dryer is not draining. (Plumbed set-up only.) Check the drain hose for blockages and correct if possible. If the problem persists contact Customer Care.
  - Air intake is blocked. Check that nothing is covering the air intake.
  - Air temperature in the space surrounding the dryer is too hot, humid or cold. The dryer is less efficient in very hot or cold conditions. Ensure the dryer is installed in a well-ventilated space. Do not operate this dryer inside a cupboard.
- 

### Why is there lint on the load after a drying cycle?

- The lint filters need to be cleaned. Remove and clean the lint filters.
  - Lint-shedding items are mixed in a load with lint-collecting items. See 'Sort your load'.
  - Clothes are over-dried and attracting lint. Use AUTO method to sense when items are at the appropriate dryness level.
- 

### Why is the fabric damaged after a drying cycle?

- Cycle settings not appropriate for the load type. Follow instructions on care labels and sort items accordingly. See 'Sort your load'.
  - Metal parts on the items or in the load may catch on fabric. Always fasten zips and other clasps before placing items in the dryer.
- 

### Why do items in the dryer keep getting tangled?

- Loads not separated before going in the dryer. Load items individually and try separating larger items from smaller items.
  - Load size is too large. Try drying smaller loads. See 'Sort your load'.
  - Cycle settings not the best option for the load type. Try SHEETS for sheets, duvet/duona covers and TOWELS for towels.
  - Delicate items not separated. Dry pantyhose, bras and stockings in a mesh bag.
- 

### Why do items in the dryer keep getting creased?

- Items have been left in the dryer after the cycle ended. Select options, and turn CREASE FREE on at the start of the cycle to minimise creasing.
  - Dryer is overloaded. Pause the cycle and remove some items.
  - Dryness level is not appropriate for the load. Select a lower dryness level.
-

## TROUBLESHOOTING

---

### Why is dye transferring onto my clothes?

- Items not sorted before going in the dryer. Separate white and coloured items into separate loads.
  - Wet items left sitting in the dryer before the drying cycle.
- 

### Why is the dryer not draining?

- Drain hose or drain is blocked. (Plumbed set-up only.) Check the drain hose and drain for blockages and correct if possible. If the problem persists contact Customer Care.
  - Drain hose not connected correctly. See the installation guide for instructions.
- 

### Why is the dryer beeping?

- The cycle has ended. Items can be removed.
  - Dryer has a fault. See 'Fault codes'.
- 

### Why is water coming from under the dryer?

- Dryer door not closed. Check nothing is obstructing the door, and close it firmly.
  - Drain hose or drain is blocked. (Plumbed set-up only.) Check the drain hose and drain for blockages and correct if possible. If the problem persists contact Customer Care.
  - Drain hose not connected correctly. See the installation guide for instructions.
- 

### Why is there water in the dryer drum after a cycle?

- Air temperature in the space surrounding the dryer is too hot, humid or cold, and water may be recondensing in the dryer. Ensure the dryer is installed in a well-ventilated space. Do not operate this dryer inside a cupboard.
- 

### Can I dry my sneakers in the dryer?

Yes, sneakers can be dried using the SHOE item type and the drying rack. See 'Fit drying rack'. Suitable for up to 2 pairs at a time.

---

### How do I refresh my shirts?

Select the relevant fibre type, and set the item type to MODERATE and the treatment to REFRESH. Suitable for up to 2 items at a time.

---

### Do I need to use the Sanitise cycle on my dryer if I used the Sanitise cycle on my washer?

No. You only need to use the SANITISE cycle on one of your products to sanitise a load.

---

## FAULTS

---

How do I know if there is a problem?

Your dryer will beep and an alert will show in the display.

What to do

First try to fix the issue and clear the alert according to the onscreen instructions or the steps in the table below.

If the problem persists

- 1 Note down the fault code.
- 2 Contact Customer Care or a Fisher & Paykel trained and supported service technician. Refer to the Service and Warranty booklet for contact details.

ALERT	WHAT TO DO
LOCKED	Press and hold the screen to unlock the controls.
CHECK FILTERS	Clean both lint filters and check they are not damaged.  Check there is nothing else trapped in the filters that may be blocking the air flow.
CLOSE DOOR	Ensure the door is firmly shut, then press ►   to resume the cycle.  Try opening and closing the door again.  Reposition the load, ensuring items are not in the way of the door.
COOLING DOWN	Wait for the dryer to cool. The cycle will resume once the drum has cooled.
ROOM TEMP LOW	The room temperature is too low for the dryer to work effectively. Ensure that the room temperature is above 5°C to avoid loss of efficiency.
ROOM TEMP HIGH	The room temperature is too hot for the dryer to work effectively. Wait for environment to cool before resuming.
MAX TIME REACHED	There are a number of reasons the maximum cycle time might be reached. Refer to 'Troubleshooting'.

## COMPLIANCE INFORMATION

### Registration cycle

The cycle for energy and water labelling in accordance with AS/NZS: 2040.2 and AS/NZS:6400 is as follows: Cotton, Item: Durable, Colour: White, Dispensing: Manual Dose, More Options - Optimise: Energy. This cycle is the recommended energy and water saving cycle for normally soiled everyday washing, equal to the rated capacity.

**Note for Testing Laboratories:** The powder detergent is placed directly into the bottom of the drum. The maximum amount of anti-foaming agent is then placed into the bottom of the drum followed by the PBIS solution. The load is then added as per AS/NZS2040.1 requirements.

### UV Sanitise (20°C)

This cycle complies with the bacterial removal requirements of GB 21551.5-2010.

Average elimination rate for the following bacteria, Staphylococcus aureus & Escherichia coli >99.99%.

Fibre: COTTON, Item Type: DURABLE, Treatment: SANITISE, Colour: DARK 20C, Soil Level: MODERATE, AutoDose: MANUAL.

### Hot Sanitise

This cycle complies with the bacterial removal requirements of GB 21551.5-2010.

Average elimination rate for the following bacteria, Staphylococcus aureus & Escherichia coli >99.99%

Fibre: MIXED, Item Type: MODERATE, Treatment: SANITISE, Colour: MIXED, Soil Level: MODERATE, AutoDose: MANUAL, More Options: SANITISE METHOD - HOT WATER.

### Allergy Care

This cycle complies with the dust removal requirements of QB/T 5958-2023. Average elimination rate for the following allergen Dermatophagoides farinae =100%

Fibre: COTTON, Item Type: MODERATE, Treatment: ALLERGY CARE, Colour: MIXED, Soil Level: MODERATE, AutoDose: MANUAL

### Woolmark Wool Care

The wool wash cycle of this machine has been tested and approved by The Woolmark Company for the washing of machine washable wool products provided that the products are washed according to the instructions on the garment label and those issued by the manufacturer of this washing machine. M2540.



Fibre: WOOL, Item Type: DELICATE, Treatment: WASH, Colour: WHITE, Soil Level: LIGHT AutoDose: MANUAL.

The wool wash cycle of this machine has been tested and approved by The Woolmark Company for the washing of wool garments labelled as "hand wash" provided that the products are washed according to the instructions on the garment label and those issued by the manufacturer of this washing machine. M2541.



Fibre: WOOL, Item Type: ULTRA DELICATE, Treatment: WASH, Colour: WHITE, Soil Level: LIGHT AutoDose: MANUAL.

## COMPLIANCE INFORMATION

---

### Woolmark Black

The wool drying cycle of this machine has been tested and approved by The Woolmark Company for the drying of machine washable wool products provided that the products are washed and dried according to the instructions on the garment label and those issued by the manufacturer of this machine. M2445.

The maximum capacity of the Woolmark Wool Care cycle is 1kg.

Approved cycle: WOOL, Item Type: DELICATE, Treatment: DRY, Method: TIMED.



### Woolmark Blue

The wool drying cycle of this machine has been tested and approved by The Woolmark Company. The cycle is suitable to dry wool garments which are labelled "hand wash" provided that the garments are washed in a Woolmark endorsed hand washing cycle and dried according to the instructions issued by the manufacturer of this machine. M2443.

The maximum capacity of the Woolmark Wool Care cycle is 1kg.

Approved cycle: WOOL, Item Type: ULTRA DELICATE, Treatment: DRY, Method: TIMED.



### Energy label cycle

The energy label cycle, in accordance with AS/NZS 2442.1 and AS/NZS 2442.2 is as follows: Cotton, Item Type: Durable, Dryness: Dry. This cycle is the recommended energy saving cycle for everyday drying, at the rated capacity.

## MANUFACTURER'S WARRANTY AND SERVICE GUIDE

---

**NZ**



**To access your Warranty and Service Guide**

Scan the QR code with your smartphone to access your warranty and book a service, or view online at <https://www.fisherpaykel.com/nz/help-and-support/warranty-information>

**AU**



**To access your Warranty and Service Guide**

Scan the QR code with your smartphone to access your warranty and book a service, refer to your separate warranty and service book or view online at <https://www.fisherpaykel.com/au/help-and-support/warranty-information>

This product has been designed for use in a domestic (residential) environment. This product is not designed for any commercial use. Any commercial use by the customer will affect this product's Manufacturer's Warranty.

Complete and keep for safe reference:

Model \_\_\_\_\_

Serial No. \_\_\_\_\_

Purchase Date \_\_\_\_\_

Purchaser \_\_\_\_\_

Dealer \_\_\_\_\_

Suburb \_\_\_\_\_

Town \_\_\_\_\_

Country \_\_\_\_\_

FISHERPAYKEL.COM

© Fisher & Paykel Appliances 2026. All rights reserved.

The models shown in this guide may not be available in all markets  
and are subject to change at any time.

The product specifications in this guide apply to the specific products and  
models described at the date of issue. Under our policy of continuous product  
improvement, these specifications may change at any time.

For current details about model and specification availability in your country,  
please go to our website or contact your local Fisher & Paykel dealer.

**433744A 04.26**